

NORDSTAR

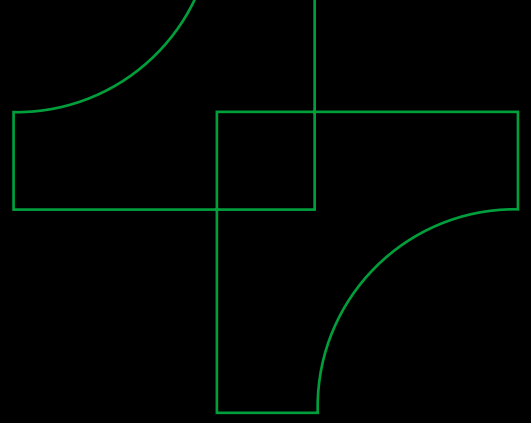

LED SOLUTIONS

Ihr kompetenter LED-Partner



Nordstar Ihr kompetenter LED-Partner!



NORDSTAR
LED SOLUTIONS

info@nord-star.de

www.nord-star.de



Nordstar lädt Sie zu einem Kennenlernbesuch ein.

Die Basis unseres Unternehmens ist mit der langjährigen Erfahrung im Bereich der Anwendung voranschreitender LED-Technik stetig gestärkt geworden. Durch die enge Kooperation mit der Metall- und Kunststoffindustrie, sind wir in der Lage projektbezogene Herstellungen, durch Einfließen innovativer Ideen wahr werden zu lassen.

Mit einem der größten Angebote an unverwechselbaren LED-Profilen und den dazugehörigen LED-Streifen, ermöglichen wir bereits jetzt die Realisierung jeglicher Beleuchtungsanwendungen. Wir zeichnen uns aus durch unsere flexible, kundenorientierte Beratung und Unterstützung, welche in den letzten Jahren sehr viel Zuspruch gewonnen hat.

Diesem Vertrauen werden wir auch in Zukunft gerecht werden!

Nordstar GmbH

Overfeldweg34, 51371 Leverkusen

Tel.:0214 50061660

Fax.:0214 50061661

www.nord-star.de

info@nord-star.de

Bestellungen bitte ausschließlich an : bestellung@nord-star.de

Anfragen bitte ausschließlich an: anfrage@nord-star.de

Alle Preise verstehen sich inkl. der gesetzlichen MwSt.



Geringste Temperatur



Maximale Temperatur



Arbeitstemperatur



Funkgesteuert



Biegeradius Horizontal



IP Schutzklasse



Pitch



Biegeradius Vertikal



Lichtfarbe warm-weiss



Lichtfarbe golden-weiss



Lichtfarbe kalt-weiss



Lichtfarbe neutral-weiss



LED´s/Segment



LED´s/Meter



Segmente/m



LED´s/Rolle



Segmentlänge/
Schnittstelle alle



Helligkeit in Lumen



Energieverbrauch



Spannungsversorgung



Orange



Blau



Rot



Grün



Nicht dimmbar



Dimmbar



Lebensdauer



Chiptype



RGB



RGB/W



BiColor (TW)



Preis



Input voltage DC12V



Input voltage DC24V



CRI Ra 80



CRI Ra 90/95



Input voltage DC48V



Input voltage AC230V



Beam Angel 120°
(Top View)



Beam Angel 120°
(Side View)



Beam Angel 180°
(Top View)



3 Jahre warrantiy



CE-complian



Achtung 230VAC
Anschluss!



Unser Service:

- Konfektionierung von LED-Streifen
- Montagefertige Konfektion von Profilen
- Doppel-, Gehrungsschnitt für Profile
- Zuschnitt der Profile auf Mass
- Verguss von LED-Profilen bis IP67
- Fertigung von Sonder-LED-Streifen
- Fertigung von Sonderprofilen
- Fertigung von Silikonprofilen oder Abdeckungen
- Fertigung von Deko-Stuckleisten
- Vor Ort Beratung
- Mit ausreichender Vorlaufzeit werden Profile in Wunschlängen produziert
- 3D Druck
- Lichtberechnung
- Pulverbeschichtung nach RAL-Code







Rufen Sie uns an, wir beraten Sie gerne!

- Bitte achten Sie auf Mengen- und Längenangaben.
- Einige unserer Profile werden nur in 3000mm geliefert
- Konfektionsarbeiten sind nicht im Preis inbegriffen

Nordstar Ihr kompetenter LED-Partner!

Inhaltsverzeichnis

•  LED-Streifen	8 - 37
•  Alu-Profil	46 - 119
4K Line	46 - 49
Star Line	50 - 59
High Frozen Line	60
Profi-Gips-Line	61-63
Wardrobe-Cloakroom-Line	64
Ground Line	65-72
Wall and Ceiling	73-76
Bidirektional Line	77-81
Round Line	83-92
Profi Corner Line	93-96
Surface Line	97-106
System Profi Line	107-111
Flex Line	112-113
Office Line	114
Super Slim Line	115
Wall Line	115-119
Plexiglas Line	120-123
Lamp Line	124
•  Silikonprofile	126- 127
•  Stuckleisten	128- 129
•  Netzteile	130- 143
Konstantspannung IP20	130
Konstantspannung IP20 Slim	131
Konstantspannung IP20 DRES	132
dimmbar über Phasen-an-/abschnitt	133
Konstantspannung Metalgehäuse...	134
Hutschiennetzteile	135
Konstantstrom Dimmbar	136
Universalnetzteile	137
Mean Well	138-142

Inhaltsverzeichnis

• ● Steuerungen und Dimmer	144- 161
Potidimmer.....	145
NLDS-02.....	146
NLDS-03.....	147
NLDS-04 bis NLDS-08.....	148
NLDS-09 bis NLDS-10 und NLLS.....	149
NLMC-01c und NLMC-06	150
NLBI-01C	151
DALI und 1-10V.....	152
CASAMBI.....	154-155
Leistungsverstärker und DMX.....	156
NLaio.....	157-160
Dimmer und Bewegungsmesser.....	161
• ● Werbetechnik.....	162 - 163
• ● Leuchten.....	164 - 173
Vario K Downlight´s.....	164
Moon Downlight DimToWarm.....	165
Downlights und Lampen.....	166
Rettungswegleuchten.....	167
Büro- und Pendelleuchten.....	168
Tisch- und Effektleuchten.....	169
Feuchtraumwannenleuchten.....	170
Mastleuchten.....	171
Flutlichtstrahler.....	172
HighBay´s.....	173
• ● Zubehör.....	174 - 181
LED-Verbinder & Verkabelung.....	174-177
Abhängungen.....	178
Stecker & Kabelverbinder.....	179
Universalwinkel, 3M, LED-Schutz.....	180
Anschlussklammern.....	181

LED-Streifen: Vielseitige Beleuchtungslösungen für jede Umgebung

LED-Streifen haben sich zu einem unverzichtbaren Bestandteil moderner Beleuchtungssysteme entwickelt. Ihre Flexibilität, Energieeffizienz und vielseitige Farbgebung machen sie ideal für eine Vielzahl von Anwendungen. Von monochromen über bi-color bis hin zu RGB, RGBW und RGB-BiColor bieten LED-Streifen eine breite Palette von Optionen, um jede Umgebung zu beleuchten und zu verschönern.

Monochrom: Simplizität trifft auf Effizienz

Monochrome LED-Streifen bieten eine einfache, aber effektive Beleuchtungslösung für verschiedene Anwendungen. Sie sind ideal für Situationen, in denen eine diskrete Beleuchtung erforderlich ist, wie zum Beispiel in Schränken, Regalen oder als Hintergrundbeleuchtung für Fernseher. Dank ihrer Energieeffizienz und Langlebigkeit tragen monochrome LED-Streifen auch zur Nachhaltigkeit bei, indem sie den Energieverbrauch reduzieren und die Lebensdauer im Vergleich zu herkömmlichen Beleuchtungsoptionen verlängern.

Bi-Color: Für subtile Farbvariationen

Bi-Color LED-Streifen ermöglichen es, zwischen zwei verschiedenen Farbtönen zu wählen, was eine subtile Anpassung der Beleuchtung je nach Stimmung oder Anforderung ermöglicht. Diese Streifen eignen sich besonders gut für den Einsatz in Wohnräumen, Restaurants oder Hotels, wo eine vielseitige Beleuchtung gewünscht wird. Durch ihre Langlebigkeit und Energieeffizienz tragen bi-color LED-Streifen auch dazu bei, den ökologischen Fußabdruck zu reduzieren und die Betriebskosten zu senken.

RGB: Farbenfrohe Vielfalt für kreative Gestaltung

RGB LED-Streifen bieten eine breite Palette von Farboptionen, die es ermöglichen, jeden Raum in ein lebendiges Farbenspiel zu verwandeln. Ob für Partydekorationen, Bühnenbeleuchtung oder Architekturakzente - RGB LED-Streifen bieten grenzenlose Möglichkeiten für kreative Gestaltung. Darüber hinaus tragen ihre geringe Wärmeentwicklung und lange Lebensdauer dazu bei, die Umweltbelastung zu verringern und die Betriebskosten zu senken.

RGBW: Die Perfektion von Farbe und Weiß

LED-Streifen kombinieren die Vielseitigkeit von RGB mit der Reinheit von Weißlicht. Diese Streifen ermöglichen nicht nur die Erzeugung von Millionen von Farben, sondern auch die präzise Einstellung von Weißlichttönen, was sie ideal für Anwendungen wie Kunstgalerien, Ausstellungsräume oder Bürobeleuchtung macht. Durch ihre energieeffiziente Technologie tragen RGBW LED-Streifen zur Reduzierung des Energieverbrauchs und zur Verbesserung der Nachhaltigkeit bei.

RGB-BiColor: Die Fusion von Flexibilität und Vielfalt

RGB-BiColor LED-Streifen kombinieren die Flexibilität von RGB mit der subtilen Variation von Bi-Color, um eine einzigartige Beleuchtungslösung zu schaffen. Mit der Möglichkeit, zwischen verschiedenen Farben und Weißtönen zu wählen, bieten diese Streifen eine unübertroffene Vielseitigkeit für eine Vielzahl von Anwendungen. Ihre energieeffiziente Technologie und lange Lebensdauer machen sie zu einer umweltfreundlichen Option für nachhaltige Beleuchtungssysteme.

Insgesamt bieten LED-Streifen mit verschiedenen LED-Chips eine flexible, energieeffiziente und vielseitige Beleuchtungslösung für eine Vielzahl von Anwendungen. Ihre Fähigkeit, Farben und Weißlicht präzise zu steuern, macht sie ideal für kreative Gestaltung und Ambiente-Beleuchtung in Wohn- und Gewerberäumen. Darüber hinaus tragen ihre Nachhaltigkeit und Langlebigkeit dazu bei, den ökologischen Fußabdruck zu verringern und die Betriebskosten langfristig zu senken.

LED-Type 1,7 Watt/Meter



LED-Streifen Type 1,7Watt/Meter, IP20, RA>80, Abstrahlwinkel 120°, Dimmbar, 10x1,6x5000mm

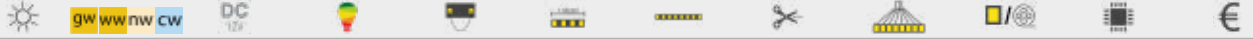

Artikel Nr.	lm/m	Lichtfarbe	VDC	W/m	Pitch	Segmete/m	LED/Seg.	trennbar alle	LED/m	Led`s/Rolle	Chip Type	Preis/Rolle
LS12gw02A	ca.230	2400K	12VDC	1,7Watt	8,33mm	20	4	5cm	80	600	2835SMD	83,95 €
LS12ww02A	ca.250	3000K	12VDC	1,7Watt	8,33mm	20	4	5cm	80	600	2835SMD	83,95 €
LS12nw02A	ca.280	4000K	12VDC	1,7Watt	8,33mm	20	4	5cm	80	600	2835SMD	83,95 €
LS12cw02A	ca.300	6000K	12VDC	1,7Watt	8,33mm	20	4	5cm	80	600	2835SMD	83,95 €

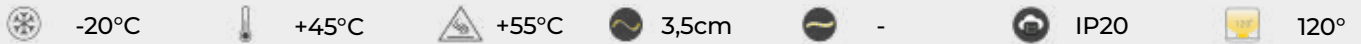

Konfektionsarbeiten sind nicht im Preis inbegriffen.

LED-Type 3,9 Watt/Meter



LED-Streifen Type 4Watt/Meter, IP20, RA>80, Abstrahlwinkel 120°, Dimmbar, 10x1,6x5000mm

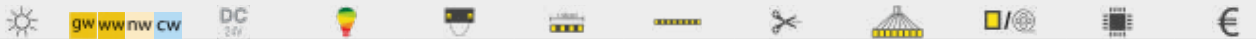

Artikel Nr.	lm/m	Lichtfarbe	VDC	W/m	Pitch	Segmete/m	LED/Seg.	trennbar alle	LED/m	Led`s/Rolle	Chip Type	Preis/Rolle
LS24gw04A	ca.430	2400K	24VDC	4Watt	12,5mm	10	8	10cm	80	400	2835SMD	90,50 €
LS24ww04A	ca.460	3000K	24VDC	4Watt	12,5mm	10	8	10cm	80	400	2835SMD	90,50 €
LS24nw04A	ca.490	4000K	24VDC	4Watt	12,5mm	10	8	10cm	80	400	2835SMD	90,50 €
LS24cw04A	ca.510	6000K	24VDC	4Watt	12,5mm	10	8	10cm	80	400	2835SMD	90,50 €

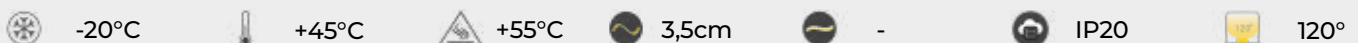

LED-Type 4,8 Watt/Meter



LED-Streifen Type 4,8Watt/Meter, IP20, RA>80, Abstrahlwinkel 120°, Dimmbar, 10x1,6x5000mm



gw ww nw cw



Artikel Nr.	lm/m	Lichtfarbe	VDC	W/m	Pitch	Segmete/m	LED/Seg.	trennbar alle	LED/m	Led`s/Rolle	Chip Type	Preis/Rolle
LS12ww48A	ca.520	3000K	12VDC	6Watt	16,67mm	20	3	5cm	60	300	2835SMD	75,80 €
LS12nw48A	ca.540	4000K	12VDC	6Watt	16,67mm	20	3	5cm	60	300	2835SMD	75,80 €
LS12cw48A	ca.560	6000K	12VDC	6Watt	16,67mm	20	3	5cm	60	300	2835SMD	75,80 €



-20°C



+45°C



+55°C



3,5cm



-



IP20



120°



Weitere LED-Streifen finden sie auf unserer Webseite oder Sie fragen bei uns an.

LED-Type 9,6 Watt/Meter



LED-Streifen Type 9,6Watt/Meter, IP20, RA>80, Abstrahlwinkel 120°, Dimmbar, 8x1,6x5000mm



gw ww nw cw



Artikel Nr.	lm/m	Lichtfarbe	VDC	W/m	Pitch	Segmete/m	LED/Seg.	trennbar alle	LED/m	Led`s/Rolle	Chip Type	Preis/Rolle
LS12gw96A	ca.720	2400K	12VDC	9,6Watt	8,33mm	40	3	2,5cm	120	600	2835SMD	125,95 €
LS12ww96A	ca.810	3000K	12VDC	9,6Watt	8,33mm	40	3	2,5cm	120	600	2835SMD	125,95 €
LS12nw96A	ca.850	4000K	12VDC	9,6Watt	8,33mm	40	3	2,5cm	120	600	2835SMD	125,95 €
LS12cw96A	ca.900	6000K	12VDC	9,6Watt	8,33mm	40	3	2,5cm	120	600	2835SMD	125,95 €



-20°C



+45°C



+55°C



3,5cm



-



IP20



120°

LED-Type 9,6 Watt/Meter



LED-Streifen Type 9,6Watt/Meter, IP20, RA>80, Abstrahlwinkel 120°, Dimmbar, 8x1,6x5000mm

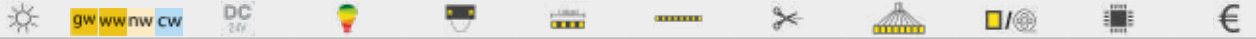

Artikel Nr.	lm/m	Lichtfarbe	VDC	W/m	Pitch	Segmete/m	LED/Seg.	trennbar alle	LED/m	Led`s/Rolle	Chip Type	Preis/Rolle
LS24gw96A	ca.710	2400K	24VDC	9,6Watt	8,33mm	20	6	5cm	120	600	2835SMD	125,95 €
LS24ww96A	ca.810	3000K	24VDC	9,6Watt	8,33mm	20	6	5cm	120	600	2835SMD	125,95 €
LS24nw96A	ca.850	4000K	24VDC	9,6Watt	8,33mm	20	6	5cm	120	600	2835SMD	125,95 €
LS24cw96A	ca.900	6000K	24VDC	9,6Watt	8,33mm	20	6	5cm	120	600	2835SMD	125,95 €

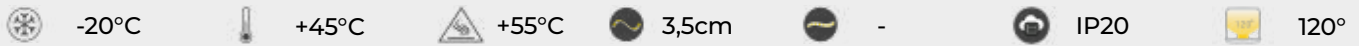

LED-Type 10 Watt/Meter



LED-Streifen Type 10Watt/Meter, IP20, RA>80, Abstrahlwinkel 120°, Dimmbar, 10x2,6x5000mm

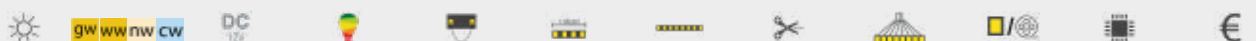

Artikel Nr.	lm/m	Lichtfarbe	VDC	W/m	Pitch	Segmete/m	LED/Seg.	trennbar alle	LED/m	Led`s/Rolle	Chip Type	Preis/Rolle
LS12ww144A	ca.1150	3000K	12VDC	10Watt	12,5mm	20	4	5cm	80	400	5050SMD	149,50 €
LS12nw144A	ca.1200	4000K	12VDC	10Watt	12,5mm	20	4	5cm	80	400	5050SMD	149,50 €
LS12cw144A	ca.1230	6000K	12VDC	10Watt	12,5mm	20	4	5cm	80	400	5050SMD	149,50 €

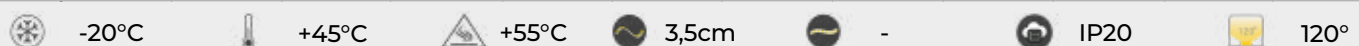

LED-Type 10 Watt/Meter



LED-Streifen Type 10Watt/Meter, IP20, RA>80, Abstrahlwinkel 120°, Dimmbar, 10x2x5000mm

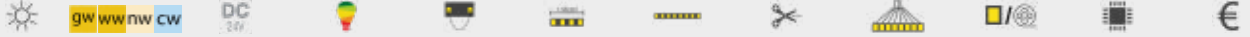

Artikel Nr.	lm/m	Lichtfarbe	VDC	W/m	Pitch	Segmete/m	LED/Seg.	trennbar alle	LED/m	Led`s/Rolle	Chip Type	Preis/Rolle
LS24ww144A	ca.1150	3000K	24VDC	10Watt	12,5mm	10	8	10cm	80	400	5050SMD	149,50 €
LS24nw144A	ca.1200	4000K	24VDC	10Watt	12,5mm	10	8	10cm	80	400	5050SMD	149,50 €
LS24cw144A	ca.1230	6000K	24VDC	10Watt	12,5mm	10	8	10cm	80	400	5050SMD	149,50 €

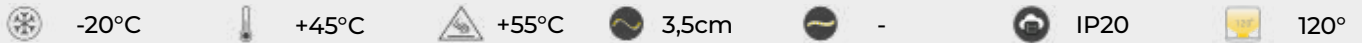

Weitere LED-Streifen finden sie auf unserer Webseite oder Sie fragen bei uns an.

LED-Type 10 Watt/Meter



LED-Streifen Type 10Watt/Meter, IP20, RA>90, Abstrahlwinkel 120°, Dimmbar, 10x2x5000mm

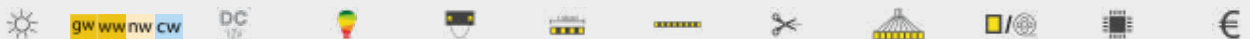
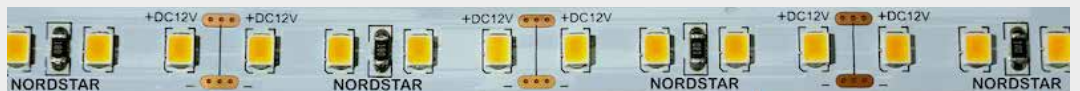

Artikel Nr.	lm/m	Lichtfarbe	VDC	W/m	Pitch	Segmete/m	LED/Seg.	trennbar alle	LED/m	Led`s/Rolle	Chip Type	Preis/Rolle
LS12gw10B	ca.1070	2400K	12VDC	10Watt	8,33mm	30	4	3,34cm	120	600	2835SMD	149,50 €
LS12ww10B	ca.1150	3000K	12VDC	10Watt	8,33mm	30	4	3,34cm	120	600	2835SMD	149,50 €
LS12nw10B	ca.1300	4000K	12VDC	10Watt	8,33mm	30	4	3,34cm	120	600	2835SMD	149,50 €
LS12cw10B	ca.1350	6000K	12VDC	10Watt	8,33mm	30	4	3,34cm	120	600	2835SMD	149,50 €

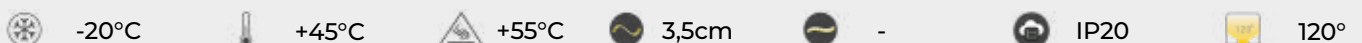

LED-Type 10 Watt/Meter



LED-Streifen Type 10Watt/Meter, IP20, RA>90, Abstrahlwinkel 120°, Dimmbar, 10x2x5000mm

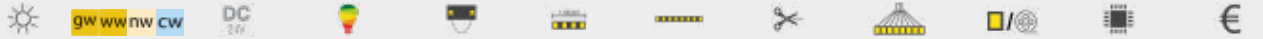

Artikel Nr.	lm/m	Lichtfarbe	VDC	W/m	Pitch	Segmete/m	LED/Seg.	trennbar alle	LED/m	Led`s/Rolle	Chip Type	Preis/Rolle
LS24gw10B	ca.1070	2400K	24VDC	10Watt	7,81mm	16	8	6,25cm	128	640	2835SMD	149,50 €
LS24ww10B	ca.1150	3000K	24VDC	10Watt	7,81mm	16	8	6,25cm	128	640	2835SMD	149,50 €
LS24nw10B	ca.1300	4000K	24VDC	10Watt	7,81mm	16	8	6,25cm	128	640	2835SMD	149,50 €
LS24cw10B	ca.1350	6000K	24VDC	10Watt	7,81mm	16	8	6,25cm	128	640	2835SMD	149,50 €

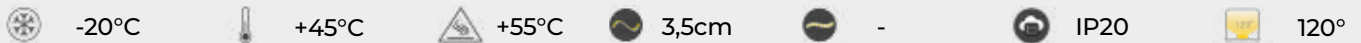

€



LED-Type 11 Watt/Meter



LED-Streifen Type 11Watt/Meter, IP20, RA>90, Abstrahlwinkel 120°, Dimmbar, 10x1,6x5000mm

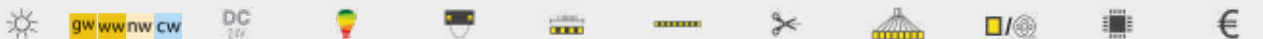

Artikel Nr.	lm/m	Lichtfarbe	VDC	W/m	Pitch	Segmete/m	LED/Seg.	trennbar alle	LED/m	Led`s/Rolle	Chip Type	Preis/Rolle
LS24gw11B	ca.950	2400K	24VDC	11Watt	5,55mm	30	6	3,33cm	180	900	2216SMD	175,95 €
LS24ww11B	ca.1000	3000K	24VDC	11Watt	5,55mm	30	6	3,33cm	180	900	2216SMD	175,95 €
LS24nw11B	ca.1100	4000K	24VDC	11Watt	5,55mm	30	6	3,33cm	180	900	2216SMD	175,95 €
LS12cw11B	ca.1180	6000K	24VDC	11Watt	5,55mm	30	6	3,33cm	180	900	2216SMD	175,95 €

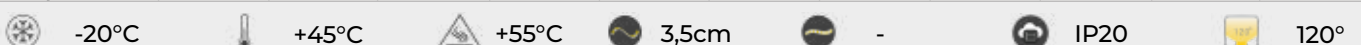

LED-Type 14 Watt/Meter



LED-Streifen Type 14Watt/Meter, IP20, RA>90, Abstrahlwinkel 120°, Dimmbar, 10x1,6x5000mm

Extrem kurze Trennstellen bis 4 LED´s/Segment

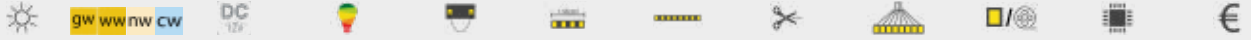

Artikel Nr.	lm/m	Lichtfarbe	VDC	W/m	Pitch	Segmete/ m	LED/Seg.	trennbar alle	LED/m	Led`s/Rolle	Chip Type	Preis/Rolle
LS12gw14B	ca.1430	2400K	12VDC	14Watt	4,81mm	52	4	1,92cm	208	1040	2835SMD	263,95 €
LS12ww14B	ca.1560	3000K	12VDC	14Watt	4,81mm	52	4	1,92cm	208	1040	2835SMD	263,95 €
LS12nw14B	ca.1830	4000K	12VDC	14Watt	4,81mm	52	4	1,92cm	208	1040	2835SMD	263,95 €
LS12cw14B	ca.1900	6000K	12VDC	14Watt	4,81mm	52	4	1,92cm	208	1040	2835SMD	263,95 €

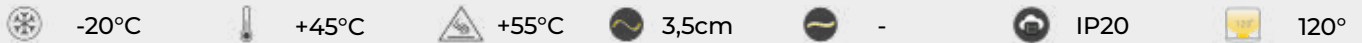

LED-Type 19,2 Watt/Meter



LED-Streifen Type 19,2Watt/Meter, IP20, RA>90, Abstrahlwinkel 120°, Dimmbar, 10x1,6x5000mm

Extrem kurze Trennstellen bis 8 LED´s/Segment

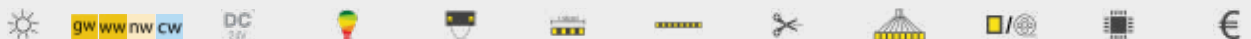

Artikel Nr.	lm/m	Lichtfarbe	VDC	W/m	Pitch	Segmete/ m	LED/Seg.	trennbar alle	LED/m	Led`s/Rolle	Chip Type	Preis/Rolle
LS24gwd19B	ca.1730	2400K	24VDC	19,2Watt	3,12mm	80	8	1,25cm	640	3200	2110SMD	263,95 €
LS24wwd19B	ca.1970	3000K	24VDC	19,2Watt	3,12mm	80	8	1,25cm	640	3200	2110SMD	263,95 €
LS24nwd19B	ca.2070	4000K	24VDC	19,2Watt	3,12mm	80	8	1,25cm	640	3200	2110SMD	263,95 €
LS24cwd19B	ca.2080	6000K	24VDC	19,2Watt	3,12mm	80	8	1,25cm	640	3200	2110SMD	263,95 €

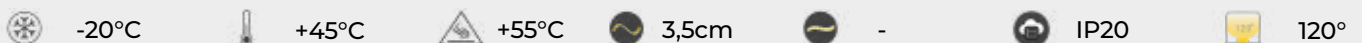

LED-Type 15 Watt/Meter



LED-Streifen Type 15Watt/Meter, IP20, RA>90, Abstrahlwinkel 120°, Dimmbar, 10x1,6x5000mm

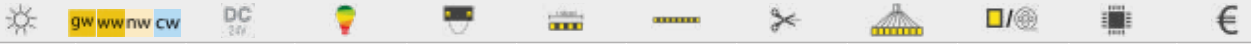

Artikel Nr.	lm/m	Lichtfarbe	VDC	W/m	Pitch	Segmete/m	LED/Seg.	trennbar alle	LED/m	Led`s/Rolle	Chip Type	Preis/Rolle
LS24gw15B	ca.1630	2400K	24VDC	15Watt	4,12mm	30	8	3,34cm	240	1200	2835SMD	329,90 €
LS24ww15B	ca.1700	3000K	24VDC	15Watt	4,12mm	30	8	3,34cm	240	1200	2835SMD	329,90 €
LS24nw15B	ca.1810	4000K	24VDC	15Watt	4,12mm	30	8	3,34cm	240	1200	2835SMD	329,90 €
LS24cw15B	ca.1980	6000K	24VDC	15Watt	4,12mm	30	8	3,34cm	240	1200	2835SMD	329,90 €

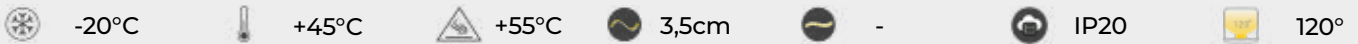

LED-Type 15 Watt/Meter



LED-Streifen Type 15Watt/Meter, IP20, RA>90, Abstrahlwinkel 120°, Dimmbar, 10x1,6x5000mm

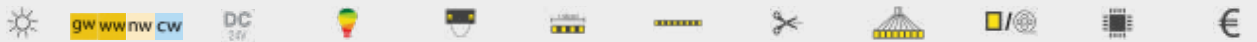

Artikel Nr.	lm/m	Lichtfarbe	VDC	W/m	Pitch	Segmete/m	LED/Seg.	trennbar alle	LED/m	Led`s/Rolle	Chip Type	Preis/Rolle
LS243515B	ca.1875	3500K	24VDC	15Watt	4,12mm	30	8	3,34cm	240	1200	2835SMD	329,90 €

Vom Lichtplaner für den Dentalbereich empfohlen

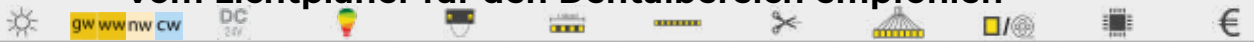

Artikel Nr.	lm/m	Lichtfarbe	VDC	W/m	Pitch	Segmete/m	LED/Seg.	trennbar alle	LED/m	Led`s/Rolle	Chip Type	Preis/Rolle
LS24DT15B	ca.1900	DTkaltweiß	24VDC	15Watt	4,12mm	30	8	3,34cm	240	1200	2835SMD	329,90 €



LED-Type 24 Watt/Meter



LED-Streifen Type 24Watt/Meter, IP20, RA>80, Abstrahlwinkel 120°, Dimmbar, 10x2x5000mm



gw ww nw cw



Artikel Nr.	lm/m	Lichtfarbe	VDC	W/m	Pitch	Segmete/m	LED/Seg.	trennbar alle	LED/m	Led`s/Rolle	Chip Type	Preis/Rolle
LS24ww24A	ca.2850	3000K	24VDC	24Watt	6,94mm	18	8	5,5cm	144	720	5630SMD	439,90 €
LS24nw24A	ca.2960	4000K	24VDC	24Watt	6,94mm	18	8	5,5cm	144	720	5630SMD	439,90 €
LS24cw24A	ca.3090	6000K	24VDC	24Watt	6,94mm	18	8	5,5cm	144	720	5630SMD	439,90 €



-20°C



+45°C



+55°C



3,5cm



-



IP20



120°



Weitere LED-Streifen finden sie auf unserer Webseite oder Sie fragen bei uns an.

LED-Type 29 Watt/Meter



LED-Streifen Type 29Watt/Meter, IP20, RA>80, Abstrahlwinkel 120°, Dimmbar, 10x2x5000mm



gw ww nw cw



Artikel Nr.	lm/m	Lichtfarbe	VDC	W/m	Pitch	Segmete/m	LED/Seg.	trennbar alle	LED/m	Led`s/Rolle	Chip Type	Preis/Rolle
LS24ww29A	ca.3520	3000K	24VDC	29Watt	6,94mm	18	8	5,5cm	144	720	5630SMD	439,90 €
LS24nw29A	ca.3640	4000K	24VDC	29Watt	6,94mm	18	8	5,5cm	144	720	5630SMD	439,90 €
LS24cw29A	ca.3770	6000K	24VDC	29Watt	6,94mm	18	8	5,5cm	144	720	5630SMD	439,90 €



-20°C



+45°C



+55°C



3,5cm



-



IP20



120°

LED-Type 30 Watt/Meter



LED-Streifen Type 30Watt/Meter, IP20, RA>90, Abstrahlwinkel 120°, Dimmbar, 10x1,6x5000mm



gw ww nw cw



Artikel Nr.	lm/m	Lichtfarbe	VDC	W/m	Pitch	Segmete/m	LED/Seg.	trennbar alle	LED/m	Led`s/Rolle	Chip Type	Preis/Rolle
LS24gw30B	ca.2900	2400K	24VDC	30Watt	4,12mm	30	16	3,34cm	480	2400	2835SMD	472,90 €
LS24ww30B	ca.3200	3000K	24VDC	30Watt	4,12mm	30	16	3,34cm	480	2400	2835SMD	472,90 €
LS24nw30B	ca.3800	4000K	24VDC	30Watt	4,12mm	30	16	3,34cm	480	2400	2835SMD	472,90 €
LS24cw30B	ca.4000	6000K	24VDC	30Watt	4,12mm	30	16	3,34cm	480	2400	2835SMD	472,90 €



-20°C



+45°C



+55°C



3,5cm



-



IP20



120°



Weitere LED-Streifen finden sie auf unserer Webseite oder Sie fragen bei uns an.

LED-Type 30 Watt/Meter



Sonderstreifen

LED-Streifen Type 30Watt/Meter, IP20, RA>90, Abstrahlwinkel 120°, Dimmbar, 15x1,6x5000mm



gw ww nw cw



Artikel Nr.	lm/m	Lichtfarbe	VDC	W/m	Pitch	Segmete/m	LED/Seg.	trennbar alle	LED/m	Led`s/Rolle	Chip Type	Preis/Rolle
LS243530B	ca.3750	3500K	24VDC	30Watt	4,12mm	30	16	3,34cm	480	2400	2835SMD	472,90 €

LED-Type 24 Watt/Meter RGB/ww 2x48LED´s/m



LED-Streifen Type 24Watt/Meter, IP20, RA>90, Abstrahlwinkel 120°, Dimmbar, 12x2x5000mm

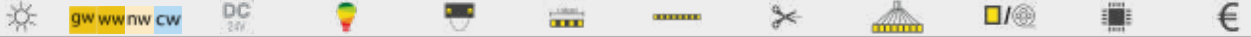

Artikel Nr.	lm/m	Lichtfarbe	VDC	W/m	Pitch	Segmete/m	LED/Seg.	trennbar alle	LED/m	Led`s/Rolle	Chip Type	Preis/Rolle
LS24mcww24A	ca.820	RGB/W 3000K	24VDC	10Watt/ 14Watt	je20,83mm	12	2x4	8,35cm	2x48	2x240	je5050SMD	307,90 €

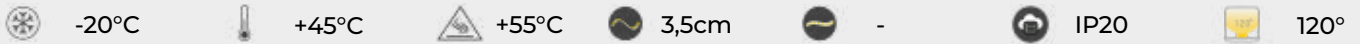

Weitere LED-Streifen finden sie auf unserer Webseite oder Sie fragen bei uns an.

LED-Type 24 Watt/Meter RGB/ww 112LED´s/m



LED-Streifen Type 24Watt/Meter, IP20, RA>90, Abstrahlwinkel 120°, Dimmbar, 12x2x5000mm

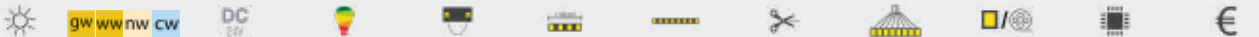

Artikel Nr.	lm/m	Lichtfarbe	VDC	W/m	Pitch	Segmete/m	LED/Seg.	trennbar alle	LED/m	Led`s/Rolle	Chip Type	Preis/Rolle
LS24mcww24B	ca.1500	RGB/W 2400K	24VDC	24Watt	8,93mm	14	8	7,14cm	112	560	5050SMD	380,50 €
LS24mcww24B	ca.1501	RGB/W 3000K	24VDC	24Watt	8,93mm	14	8	7,14cm	112	560	5050SMD	380,50 €
LS24mcww24B	ca.1502	RGB/W 4000K	24VDC	24Watt	8,93mm	14	8	7,14cm	112	560	5050SMD	380,50 €
LS24mcww24B	ca.1503	RGB/W 6000K	24VDC	24Watt	8,93mm	14	8	7,14cm	112	560	5050SMD	380,50 €



LED-Type 30 Watt/Meter RGB/ww+cw 112LED´s/m



**LED-Streifen Type 30Watt/Meter, IP20, RA>90, Abstrahlwinkel 120°, Dimmbar,
15x2x5000mm**

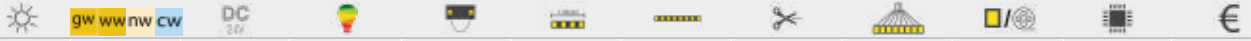

Artikel Nr.	lm/m	Lichtfarbe	VDC	W/m	Pitch	Segmete/ m	LED/Seg.	trennbar alle	LED/m	Led`s/ Rolle	Chip Type	Preis/ Rolle
LS24mcbi30A	ca.2560	RGB 3000-6500K	24VDC	30Watt	8,93mm	14	8	7,14cm	112	560	5050SMD	439,95 €



LED-Type 13 Watt/Meter Bi-Color 288 LED´s/m



**LED-Streifen Type 13Watt/Meter, 2x6,5W/m, IP20, RA>90, Abstrahlwinkel 120°,
Dimmbar, 10x2x5000mm**

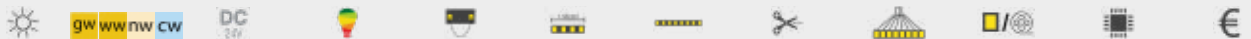

Artikel Nr.	lm/m	Lichtfarbe	VDC	W/m	Pitch	Segmete/ m	LED/Seg.	trennbar alle	LED/m	Led`s/ Rolle	Chip Type	Preis/ Rolle
LS24bi13B	ca.1400	2400-6800K	24VDC	13Watt	je 6,94mm	18	16	5,55cm	288	1440	2216SMD	274,95 €



LED-Type 26 Watt/Meter Bi-Color 416 LED´s/m



**LED-Streifen Type 26Watt/Meter, 2x13W/m, IP20, RA>90, Abstrahlwinkel 120°,
Dimmbar, 12x2x5000mm**

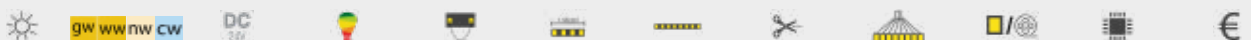

Artikel Nr.	lm/m	Lichtfarbe	VDC	W/m	Pitch	Segmete/ m	LED/Seg.	trennbar alle	LED/m	Led`s/ Rolle	Chip Type	Preis/ Rolle
LS24bi26B	ca.2600	2400-6500K	24VDC	26Watt	je 4,8mm	26	16	38,4mm	416	2080	2216SMD	329,90 €



LED-Type 10 Watt/Meter RGB



LED-Streifen Type 14,4Watt/Meter, IP20, RA>80, Abstrahlwinkel 120°, Dimmbar, 10x2x5000mm

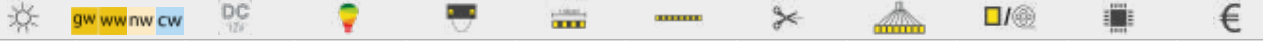

Artikel Nr.	lm/m	Lichtfarbe	VDC	W/m	Pitch	Segmete/m	LED/Seg.	trennbar alle	LED/m	Led`s/Rolle	Chip Type	Preis/Rolle
LS12mc10	ca.520	RGB	12VDC	10Watt	12,5mm	20	4	5cm	80	400	5050SMD	183,50 €
LS24mc10	ca.520	RGB	24VDC	10Watt	12,5mm	10	8	10cm	80	400	5050SMD	183,50 €

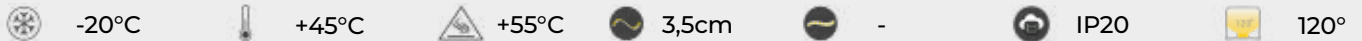

Weitere LED-Streifen finden sie auf unserer Webseite oder Sie fragen bei uns an.

LED-Type 17,2 Watt/Meter RGB



LED-Streifen Type 17,2Watt/Meter, IP20, RA>80, Abstrahlwinkel 120°, Dimmbar, 10x2x5000mm

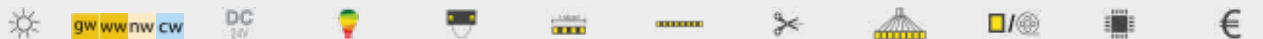

Artikel Nr.	lm/m	Lichtfarbe	VDC	W/m	Pitch	Segmete/m	LED/Seg.	trennbar alle	LED/m	Led`s/Rolle	Chip Type	Preis/Rolle
LS24mc18	ca.1000	RGB	24VDC	17,2Watt	4,17mm	40	6	2,5cm	240	1000	3838SMD	438,90 €

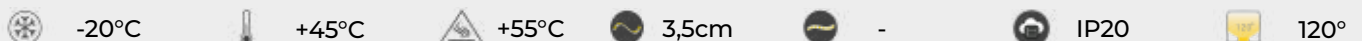

LED-Type 4,8 Watt/Meter



LED-Streifen Type 4,8Watt/Meter, flexible Bogenverlegung, IP20, RA>80, Abstrahlwinkel 120°, Dimmbar, 8x1,6x5000mm

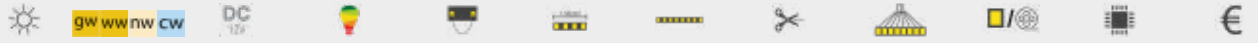

Artikel Nr.	lm/m	Lichtfarbe	VDC	W/m	Pitch	Segmete/m	LED/Seg.	trennbar alle	LED/m	Led`s/Rolle	Chip Type	Preis/Rolle
LS12gw48AKA	ca.490	2400K	12VDC	6Watt	16,67mm	20	3	5cm	60	300	2835SMD	155,95 €
LS12ww48AKA	ca.520	3000K	12VDC	6Watt	16,67mm	20	3	5cm	60	300	2835SMD	155,95 €
LS12nw48AKA	ca.540	4000K	12VDC	6Watt	16,67mm	20	3	5cm	60	300	2835SMD	155,95 €
LS12cw48AKA	ca.560	5000K	12VDC	6Watt	16,67mm	20	3	5cm	60	300	2835SMD	155,95 €



LED-Type 4,8 Watt/Meter, Farbig



LED-Streifen Type 4,8Watt/Meter, flexible Bogenverlegung, IP20, Abstrahlwinkel 120°, Dimmbar 8x1,6x5000mm

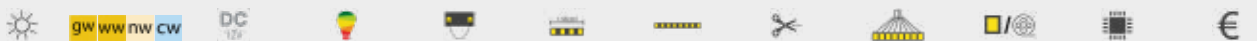

Artikel Nr.	lm/m	Lichtfarbe	VDC	W/m	Pitch	Segmete/m	LED/Seg.	trennbar alle	LED/m	Led`s/Rolle	Chip Type	Preis/Rolle
LS12rt48AK	ca.200 635nm	rt	12VDC	6Watt	16,67mm	20	3	5cm	60	300	2835SMD	165,95 €
LS12gn48AK	ca.300 517nm	gn	12VDC	6Watt	16,67mm	20	3	5cm	60	300	2835SMD	165,95 €
LS12bl48AK	ca.130 455nm	bl	12VDC	6Watt	16,67mm	20	3	5cm	60	300	2835SMD	165,95 €
LS12or48AK	ca.260 610nm	or	12VDC	6Watt	16,67mm	20	3	5cm	60	300	2835SMD	165,95 €



LED-Type 7,2 Watt/Meter, RGB



LED-Streifen Type 7,2Watt/Meter, flexible Bogenverlegung, IP20, Abstrahlwinkel 120°, Dimmbar 8x1,6x5000mm

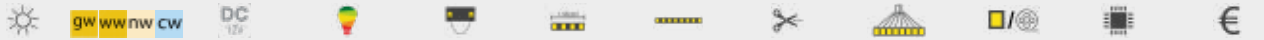

Artikel Nr.	Im/m	Lichtfarbe	VDC	W/m	Pitch	Segmete/m	LED/Seg.	trennbar alle	LED/m	Led`s/Rolle	Chip Type	Preis/Rolle
LS12mc72AK	ca.200	RGB	12VDC	7,2Watt	20,83mm	3	16	6,25cm	48	240	5050SMD	189,95 €

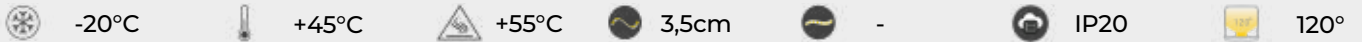

Weitere LED-Streifen finden sie auf unserer Webseite oder Sie fragen bei uns an.

LED-Type 10 Watt/Meter, RGB/



LED-Streifen Type 10Watt/Meter, flexible Bogenverlegung, IP20, Abstrahlwinkel 120°, Dimmbar 12x1,6x5000mm

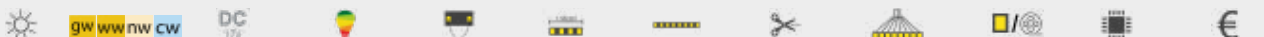

Artikel Nr.	Im/m	Lichtfarbe	VDC	W/m	Pitch	Segmete/m	LED/Seg.	trennbar alle	LED/m	Led`s/Rolle	Chip Type	Preis/Rolle
LS12mcw10AK	ca.560	RGB/W	12VDC	10Watt	20,83mm	3	16	6,25cm	48	240	5050SMD	239,90 €

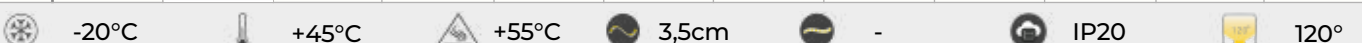

LED-Type 4,8 Watt/Meter Farbig



LED-Streifen Type 4,8Watt/Meter, IP20, Abstrahlwinkel 120°, Dimmbar, 10x1,6x5000mm



Artikel Nr.	lm/m	Lichtfarbe	VDC	W/m	Pitch	Segmete/ m	LED/Seg.	trennbar alle	LED/m	Led`s/ Rolle	Chip Type	Preis/ Rolle
LS12rt48	ca.250 635nm	rt	12VDC	6Watt	16,67mm	20	3	5cm	60	300	2835SMD	109,95 €
LS12gn48	ca.1425 517nm	gn	12VDC	6Watt	16,67mm	20	3	5cm	60	300	2835SMD	109,95 €
LS12bl48	ca.420 455nm	bl	12VDC	6Watt	16,67mm	20	3	5cm	60	300	2835SMD	109,95 €
LS12or48	ca.200 610nm	or	12VDC	6Watt	16,67mm	20	3	5cm	60	300	2835SMD	109,95 €

-20°C



LED-Type 15 Watt/Meter Farbig



LED-Type 15 Watt/Meter Farbig

LED-Streifen Type 15Watt/Meter, IP20, Abstrahlwinkel 120°, Dimmbar, 10x1,6x5000mm



Artikel Nr.	lm/m	Lichtfarbe	VDC	W/m	Pitch	Segmete/ m	LED/Seg.	trennbar alle	LED/m	Led`s/ Rolle	Chip Type	Preis/ Rolle
LS24rt15	ca.1230 635nm	rt	24VDC	6Watt	4,12mm	30	8	3,34cm	240	1200	2835SMD	399,90 €
LS24gn15	ca.10100 517nm	gn	24VDC	6Watt	4,12mm	30	8	3,34cm	240	1200	2835SMD	399,90 €
LS24bl15	ca.2200 455nm	bl	24VDC	6Watt	4,12mm	30	8	3,34cm	240	1200	2835SMD	399,90 €
LS24or15	ca.1030 610nm	or	24VDC	6Watt	4,12mm	30	8	3,34cm	240	1200	2835SMD	399,90 €

-20°C
 +45°C
 +55°C
 3,5cm
 -
 IP20
 120°

LED-Type 10 Watt/Meter Seitenlicht



LED-Streifen Type 9,6Watt/Meter, IP20, Abstrahlwinkel 120°, Dimmbar
10x1,6x5000mm

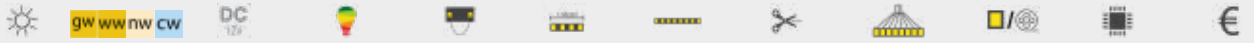

Artikel Nr.	lm/m	Lichtfarbe	VDC	W/m	Pitch	Segmete/m	LED/Seg.	trennbar alle	LED/m	Led`s/Rolle	Chip Type	Preis/Rolle
LS12gw10sl	ca.500	2400K	12VDC	10Watt	8,33mm	40	3	2,5cm	120	600	335SMD	199,95 €
LS12ww10sl	ca.580	3000K	12VDC	10Watt	8,33mm	40	3	2,5cm	120	600	335SMD	199,95 €
LS12nw10sl	ca.650	4000K	12VDC	10Watt	8,33mm	40	3	2,5cm	120	600	335SMD	199,95 €
LS12cw10sl	ca.680	6000K	12VDC	10Watt	8,33mm	40	3	2,5cm	120	600	335SMD	199,95 €

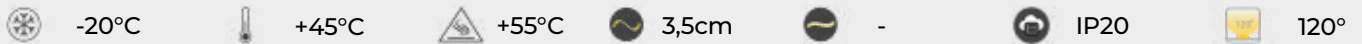

LED-Type 10 Watt/Meter Seitenlicht Farbig



LED-Streifen Type 9,6Watt/Meter, IP20, Abstrahlwinkel 120°, Dimmbar
10x1,6x5000mm

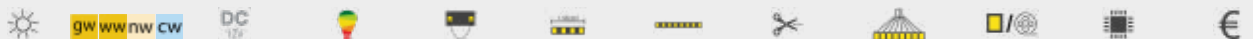

Artikel Nr.	lm/m	Lichtfarbe	VDC	W/m	Pitch	Segmete/m	LED/Seg.	trennbar alle	LED/m	Led`s/Rolle	Chip Type	Preis/Rolle
LS12rt10sl	ca.360 635nm	rt	12VDC	10Watt	8,33mm	40	3	2,5cm	120	600	335SMD	229,95 €
LS12gn10sl	ca.1500 517nm	gn	12VDC	10Watt	8,33mm	40	3	2,5cm	120	600	335SMD	229,95 €
LS12bl10sl	ca.550 455nm	bl	12VDC	10Watt	8,33mm	40	3	2,5cm	120	600	335SMD	229,95 €
LS12or10sl	ca.310 610nm	or	12VDC	10Watt	8,33mm	40	3	2,5cm	120	600	335SMD	229,95 €



LED-Streifen mit IP-Schutz



LED-Type 9,6 Watt/Meter Double Line Neon



LED-Streifen Type 9,6Watt/Meter, IP20, Abstrahlwinkel 120°, Dimmbar, 10x1,6x5000mm

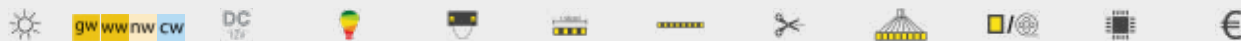

Artikel Nr.	lm/m	Lichtfarbe	VDC	W/m	Pitch	Segmete/m	LED/Seg.	trennbar alle	LED/m	Led`s/Rolle	Chip Type	Preis/Rolle
LS24BDgw1068	ca.490	2400K	12VDC	10Watt	8,33mm	40	3	2,5cm	120	600	2835SMD	329,95 €
LS24BDww1068	ca.520	3000K	12VDC	10Watt	8,33mm	40	3	2,5cm	120	600	2835SMD	329,95 €
LS24BDnw1068	ca.540	4000K	12VDC	10Watt	8,33mm	40	3	2,5cm	120	600	2835SMD	329,95 €
LS24BDcw1068	ca.560	6000K	12VDC	10Watt	8,33mm	40	3	2,5cm	120	600	2835SMD	329,95 €

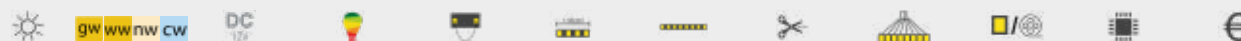
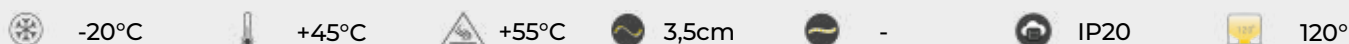

Artikel Nr.	lm/m	Lichtfarbe	VDC	W/m	Pitch	Segmete/m	LED/Seg.	trennbar alle	LED/m	Led`s/Rolle	Chip Type	Preis/Rolle
LS24BDrt1068	ca.460 635nm	rt	12VDC	10Watt	8,33mm	40	3	2,5cm	120	600	2835SMD	329,95 €
LS24BDgn1068	ca.1800 517nm	gn	12VDC	10Watt	8,33mm	40	3	2,5cm	120	600	2835SMD	329,95 €
LS24BDbl1068	ca.750 455nm	bl	12VDC	10Watt	8,33mm	40	3	2,5cm	120	600	2835SMD	329,95 €
LS24BDor1068	ca.360 610nm	or	12VDC	10Watt	8,33mm	40	3	2,5cm	120	600	2835SMD	329,95 €

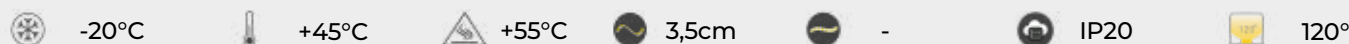

LED-Type 9,6 Watt/Meter Neon Flex



**LED-Streifen Type 9,6Watt/Meter, IP20, Abstrahlwinkel 120°, Dimmbar,
12x4x5000mm**

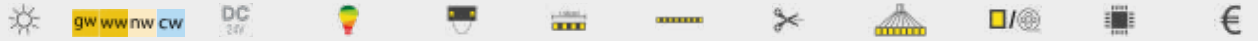

Artikel Nr.	lm/m	Lichtfarbe	VDC	W/m	Pitch	Segmete/m	LED/Seg.	trennbar alle	LED/m	Led`s/Rolle	Chip Type	Preis/Rolle
LS24gw10NF	ca.500	2400K	24VDC	9,6Watt	8,33mm	20	6	5cm	120	600	335SMD	199,95 €
LS24ww10NF	ca.580	3000K	24VDC	9,6Watt	8,33mm	20	6	5cm	120	600	335SMD	199,95 €
LS24nw10NF	ca.650	4000K	24VDC	9,6Watt	8,33mm	20	6	5cm	120	600	335SMD	199,95 €
LS24cw10NF	ca.680	6000K	24VDC	9,6Watt	8,33mm	20	6	5cm	120	600	335SMD	199,95 €

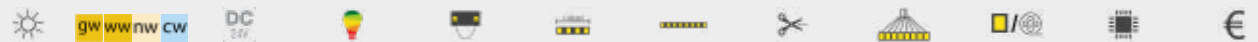
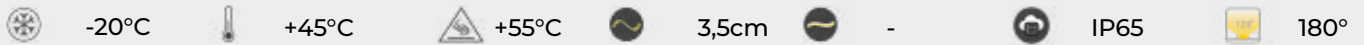

Artikel Nr.	lm/m	Lichtfarbe	VDC	W/m	Pitch	Segmete/m	LED/Seg.	trennbar alle	LED/m	Led`s/Rolle	Chip Type	Preis/Rolle
LS24rt10NF	ca.100 635nm	rt	24VDC	9,6Watt	8,33mm	20	6	5cm	120	600	335SMD	229,95 €
LS24gn10NF	ca.1000 517nm	gn	24VDC	9,6Watt	8,33mm	20	6	5cm	120	600	335SMD	229,95 €
LS24bl10NF	ca.60 455nm	bl	24VDC	9,6Watt	8,33mm	20	6	5cm	120	600	335SMD	229,95 €
LS24or10NF	ca.80 610nm	or	24VDC	9,6Watt	8,33mm	20	6	5cm	120	600	335SMD	229,95 €

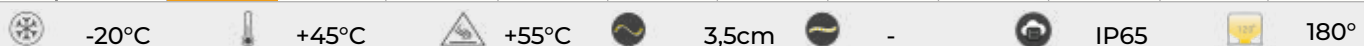

LED-Type 9,6 Watt/Meter Double Line Neon

LED-Streifen Type 9,6Watt/Meter, IP20, Abstrahlwinkel 120°, Dimmbar, 22x13x5000mm

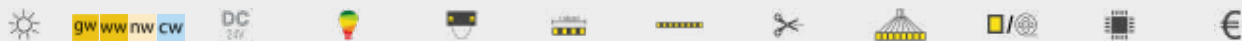

Artikel Nr.	lm/m	Lichtfarbe	VDC	W/m	Pitch	Segmete/m	LED/Seg.	trennbar alle	LED/m	Led`s/Rolle	Chip Type	Preis/Rolle
LS24gw10NL	ca.490	2400K	24VDC	10Watt	8,33mm	20	6	5cm	120	600	2835SMD	329,95 €
LS24ww10NL	ca.520	3000K	24VDC	10Watt	8,33mm	20	6	5cm	120	600	2835SMD	329,95 €
LS24nw10NL	ca.540	4000K	24VDC	10Watt	8,33mm	20	6	5cm	120	600	2835SMD	329,95 €
LS24cw10NL	ca.560	6000K	24VDC	10Watt	8,33mm	20	6	5cm	120	600	2835SMD	329,95 €

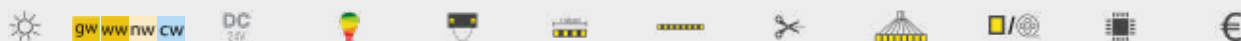
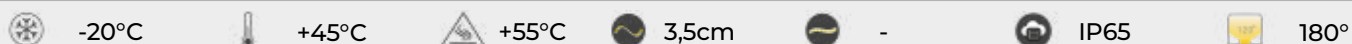

Artikel Nr.	lm/m	Lichtfarbe	VDC	W/m	Pitch	Segmete/m	LED/Seg.	trennbar alle	LED/m	Led`s/Rolle	Chip Type	Preis/Rolle
LS24rt10NL	ca.460 635nm	rt	24VDC	10Watt	8,33mm	20	6	5cm	120	600	2835SMD	329,95 €
LS24gn10NL	ca.1800 517nm	gn	24VDC	10Watt	8,33mm	20	6	5cm	120	600	2835SMD	329,95 €
LS24bl10NL	ca.750 455nm	bl	24VDC	10Watt	8,33mm	20	6	5cm	120	600	2835SMD	329,95 €
LS24or10NL	ca.360 610nm	or	24VDC	10Watt	8,33mm	20	6	5cm	120	600	2835SMD	329,95 €

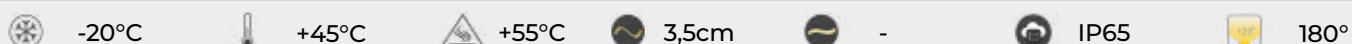

DIMM TO WARM



LED-Type 15 Watt/Meter

Sonderstreifen

LED-Streifen Type 14,4Watt/Meter, IP20, RA>90, Abstrahlwinkel 120°, Dimm To Warm, 10x1,6x5000mm

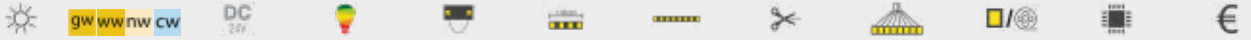

Artikel Nr.	lm/m	Lichtfarbe	VDC	W/m	Pitch	Segmete/ m	LED/Seg.	trennbar alle	LED/m	Led`s/ Rolle	Chip Type	Preis/ Rolle
LS24dwgw14B	ca.1200	2300-3000K	24VDC	14,4Watt	7,14mm – 1,43mm	10	2 x 7	10cm	140	700	2835SMD	239,90 €
LS24dwgn14B	ca.1300	2300-4000K	24VDC	14,4Watt	7,14mm – 1,43mm	10	2 x 7	10cm	140	700	2835SMD	239,90 €
LS24dwwn14B	ca.1300	3000-4000K	24VDC	14,4Watt	7,14mm – 1,43mm	10	2 x 7	10cm	140	700	2835SMD	239,90 €

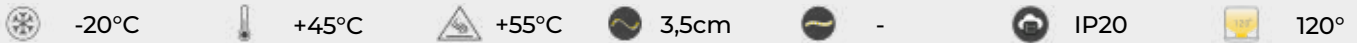

Weitere LED-Streifen finden sie auf unserer Webseite oder Sie fragen bei uns an.

LED-Streifen Type 15Watt/Meter, IP20, RA>80, Abstrahlwinkel 120°, Dimm To Warm, 10x1,6x5000mm

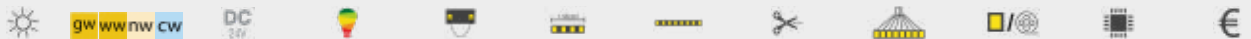

Artikel Nr.	lm/m	Lichtfarbe	VDC	W/m	Pitch	Segmete/ m	LED/Seg.	trennbar alle	LED/m	Led`s/ Rolle	Chip Type	Preis/ Rolle
LS24dwgw15B	ca.1300	2300-3000K	24VDC	15Watt	7,14mm – 14,3mm	10	2 x 8	10cm	128	640	2835SMD	259,90 €
LS24dwgn15B	ca.1400	2300-4000K	24VDC	15Watt	7,14mm – 14,3mm	10	2 x 8	10cm	128	640	2835SMD	259,90 €
LS24dwwn15B	ca.1450	3000-4000K	24VDC	15Watt	7,14mm – 14,3mm	10	2 x 8	10cm	128	640	2835SMD	259,90 €

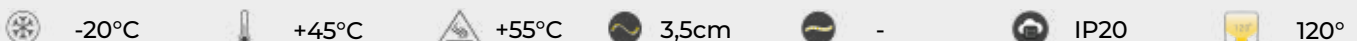

LED-Streifen Type 21Watt/Meter, IP20, RA>80, Abstrahlwinkel 120°, Dimm To Warm, 10x1,6x5000mm



gw ww nw cw



Artikel Nr.	lm/m	Lichtfarbe	VDC	W/m	Pitch	Segmete/m	LED/Seg.	trennbar alle	LED/m	Led` s/ Rolle	Chip Type	Preis/ Rolle
LS24dwgw21B	ca.1550	2300-3000K	24VDC	21Watt	6,25mm – 12,5mm	10	2 x 8	10cm	160	480	2835SMD	299,90 €
LS24dwgn21B	ca.1650	2300-3000K	24VDC	21Watt	6,25mm – 12,5mm	10	2 x 8	10cm	160	480	2835SMD	299,90 €
LS24dwwn21B	ca.1700	3000-4000K	24VDC	21Watt	6,25mm – 12,5mm	10	2 x 8	10cm	160	480	2835SMD	299,90 €



-20°C



+45°C



+55°C



3,5cm



-



IP20



120°

LED-Type 10 Watt/Meter

Sonderstreifen

LED-Streifen Type 10Watt/Meter, IP20, RA>90, Abstrahlwinkel 120°, Dimmbar, 10x2x5000mm



gw ww nw cw



Artikel Nr.	lm/m	Lichtfarbe	VDC	W/m	Pitch	Segmete/m	LED/Seg.	trennbar alle	LED/m	Led` s/ Rolle	Chip Type	Preis/ Rolle
LS243510B	ca.1300	4000K	24VDC	10Watt	7,81mm	16	8	6,25cm	128	640	2835SMD	129,95 €



-20°C



+45°C



+55°C



3,5cm



-



IP20



120°

LED-Type 14 Watt/Meter

LED-Streifen Type 14Watt/Meter, IP20, RA>90, Abstrahlwinkel 120°, Dimmbar, 10x2x5000mm



gw ww nw cw



Artikel Nr.	lm/m	Lichtfarbe	VDC	W/m	Pitch	Segmete/m	LED/Seg.	trennbar alle	LED/m	Led` s/ Rolle	Chip Type	Preis/ Rolle
LS242414B	ca.1800	2400K	24VDC	14Watt	7,81mm	16	8	6,25cm	128	640	2835SMD	159,95 €
LS243014B	ca.1870	3000K	24VDC	14Watt	7,81mm	16	8	6,25cm	128	640	2835SMD	159,95 €
LS244014B	ca.1950	4000K	24VDC	14Watt	7,81mm	16	8	6,25cm	128	640	2835SMD	159,95 €
LS245014B	ca.2000	5000K	24VDC	14Watt	7,81mm	16	8	6,25cm	128	640	2835SMD	159,95 €



-20°C



+45°C



+55°C



3,5cm



-



IP20



120°

One Line Serie



LED-Streifen Type 10Watt/Meter, IP20, RA>90, Abstrahlwinkel 180°, 8x1,6x5000mm

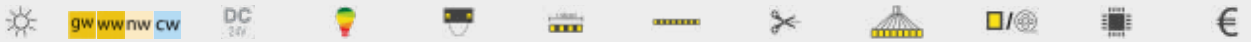

Artikel Nr.	lm/m	Lichtfarbe	VDC	W/m	Pitch	Segmete/m	LED/Seg.	trennbar alle	LED/m	Led`s/Rolle	Chip Type	Preis/Rolle
LS24ww100L	ca.910	3000K	24VDC	10Watt	2,08mm	20	24	5cm	480	2400	COB	205,90 €
LS24nw100L	ca.980	4000K	24VDC	10Watt	2,08mm	20	24	5cm	480	2400	COB	205,90 €
LS24cw100L	ca.980	6000K	24VDC	10Watt	2,08mm	20	24	5cm	480	2400	COB	205,90 €



LED-Streifen Type 10Watt/Meter, IP20, RA>80, Abstrahlwinkel 180°, One Line Serie, 8x1,6x5000mm

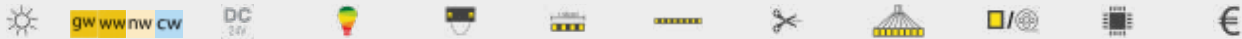

Artikel Nr.	lm/m	Lichtfarbe	VDC	W/m	Pitch	Segmete/m	LED/Seg.	trennbar alle	LED/m	Led`s/Rolle	Chip Type	Preis/Rolle
LS24rt100L	ca.150 635nm	rt	24VDC	10Watt	2,08mm	20	24	5cm	480	2400	COB	229,90 €
LS24gn100L	ca.900 517nm	gn	24VDC	10Watt	2,08mm	20	24	5cm	480	2400	COB	229,90 €
LS24bl100L	ca.750 455nm	bl	24VDC	10Watt	2,08mm	20	24	5cm	480	2400	COB	229,90 €

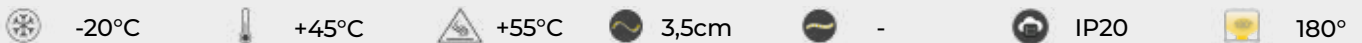

LED-Streifen Type 15Watt/Meter, IP20, Abstrahlwinkel 180°, 10x1,6x5000mm

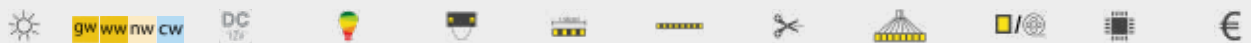

Artikel Nr.	lm/m	Lichtfarbe	VDC	W/m	Pitch	Segmete/m	LED/Seg.	trennbar alle	LED/m	Led`s/Rolle	Chip Type	Preis/Rolle
LS24mcl50L	ca.670	RGB	24VDC	15Watt	2,083mm	40	12	2,5cm	480	2400	COB	249,00 €



One Line Serie



LED-Streifen Type 14Watt/Meter, IP20, RA>90, Abstrahlwinkel 180°, Bi-Color, 10x1,6x5000mm

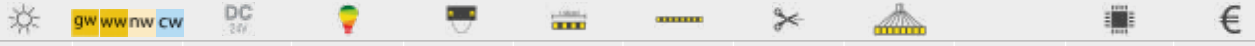
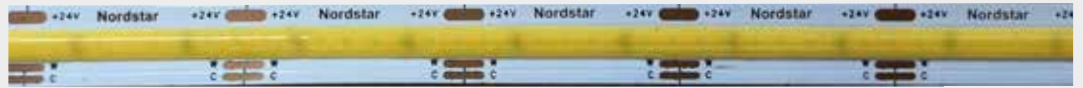

Artikel Nr.	lm/m	Lichtfarbe	VDC	W/m	Pitch	Segmete/ LED/Seg. m	trennbar alle	LED/m	Led` s/ Rolle	Chip Type	Preis/ Rolle	
LS24bi14OL	ca.1300	3000/6800K	24VDC	14Watt	1,64mm 3,29mm	38	16	2,63cm	608	3040	COB	239,00 €

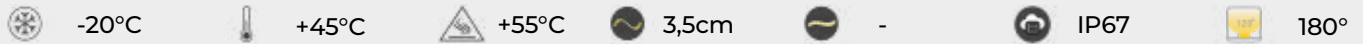

LED-Streifen Type 10Watt/Meter, IP67, RA>80, Abstrahlwinkel 120°, 12x4x5000mm

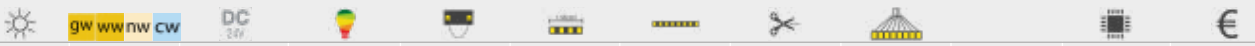
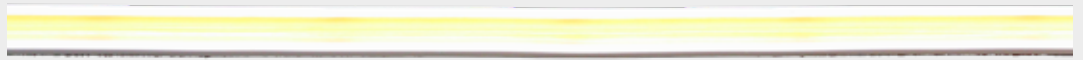

Artikel Nr.	lm/m	Lichtfarbe	VDC	W/m	Pitch	Segmete/ LED/Seg. m	trennbar alle	LED/m	Led` s/ Rolle	Chip Type	Preis/ Rolle	
LS24ww10oL68	ca.650	3000K	24VDC	9Watt	2,08mm	20	24	5cm	480	2400	COB	349,90 €

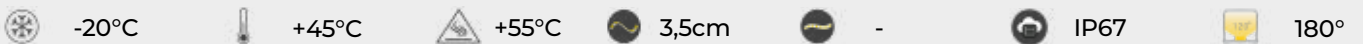

LED-Streifen Type 10Watt/Meter, IP20, RA>90, Abstrahlwinkel 120°, Dimmbar, 10x1,6x5000mm



Artikel Nr.	lm/m	Lichtfarbe	VDC	W/m	Pitch	Segmete/ LED/Seg. m	trennbar alle	LED/m	Led` s/ Rolle	Chip Type	Preis/ Rolle	
LS24gw100Lsl	ca.270	2400K	24VDC	10Watt	2,08mm	30	16	3,33cm	480	2400	COB	229,95 €
LS24ww100Lsl	ca.308	3000K	24VDC	14Watt	2,08mm	30	16	3,33cm	480	2400	COB	229,95 €
LS24nw100Lsl	ca.330	4000K	24VDC	14Watt	2,08mm	30	16	3,33cm	480	2400	COB	229,95 €
LS24cw100Lsl	ca.350	6000K	24VDC	10Watt	2,08mm	30	16	3,33cm	480	2400	COB	229,95 €

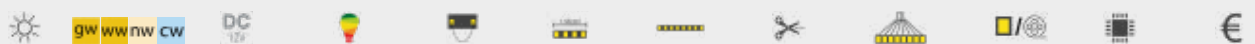
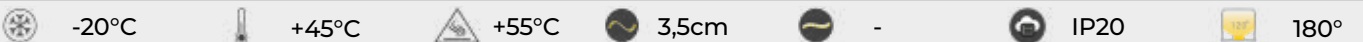

Artikel Nr.	lm/m	Lichtfarbe	VDC	W/m	Pitch	Segmete/ LED/Seg. m	trennbar alle	LED/m	Led` s/ Rolle	Chip Type	Preis/ Rolle	
LS24mcww18OL	ca.845	RGB/W	24VDC	18Watt	1,19mm	30	28	3,33cm	840	4200	COB	329,95 €

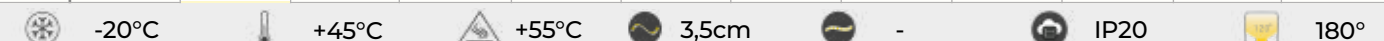

LED-Streifen mit IP-Schutz



LED-Type 9,6 Watt/Meter Round Line Neon*

LED-Streifen Type 10Watt/Meter, flexible , IP68, RA>80, Abstrahlwinkel 360°, Dimmbar, 22x5000mm



Artikel Nr.	lm/m	Lichtfarbe	VDC	W/m	Pitch	Segmete/m	LED/Seg.	trennbar alle	LED/m	Led`s/Rolle	Chip Type	Preis/Rolle
LS24RLgw1068	ca.490	2400K	24VDC	10Watt	8,33mm	20	12	5cm	240	1200	2835SMD	449,99 €
LS24RLww1068	ca.520	3000K	24VDC	10Watt	8,33mm	20	12	5cm	240	1200	2835SMD	449,99 €
LS24RLnw1068	ca.540	4000K	24VDC	10Watt	8,33mm	20	12	5cm	240	1200	2835SMD	449,99 €
LS24RLcw1068	ca.560	6000K	24VDC	10Watt	8,33mm	20	12	5cm	240	1200	2835SMD	449,99 €

-20°C +45°C +55°C 3,5cm 3,5cm IP68 360°



Artikel Nr.	lm/m	Lichtfarbe	VDC	W/m	Pitch	Segmete/m	LED/Seg.	trennbar alle	LED/m	Led`s/Rolle	Chip Type	Preis/Rolle
LS12RLrt1068	ca.460 635nm	rt	24VDC	10Watt	8,33mm	20	12	5cm	240	1200	2835SMD	449,99 €
LS12RLgn1068	ca.1800 517nm	gn	24VDC	10Watt	8,33mm	20	12	5cm	240	1200	2835SMD	449,99 €
LS12RLbl1068	ca.750 455nm	bl	24VDC	10Watt	8,33mm	20	12	5cm	240	1200	2835SMD	449,99 €
LS12RLor1068	ca.360 610nm	or	24VDC	10Watt	8,33mm	20	12	5cm	240	1200	2835SMD	449,99 €

-20°C +45°C +55°C 3,5cm 3,5cm IP68 360°

LED-Sonderstreifen



LED-Type 9,6 Watt/Meter

LED-Streifen Type 9,6Watt/Meter, flexible , IP20, RA>80, Abstrahlwinkel 120°, Dimmbar, 5x1,6x5000mm



gw ww nw cw



Artikel Nr.	lm/m	Lichtfarbe	VDC	W/m	Pitch	Segmete/ m	LED/Seg.	trennbar alle	LED/m	Led`s/ Rolle	Chip Type	Preis/ Rolle
LS12gw10XS	ca.1050	2400K	12VDC	10Watt	8,33mm	40	3	2,5cm	120	600	2835SMD	165,90 €
LS12ww10XS	ca.11500	3000K	12VDC	10Watt	8,33mm	40	3	2,5cm	120	600	2835SMD	165,90 €
LS12nw10XS	ca.1280	4000K	12VDC	10Watt	8,33mm	40	3	2,5cm	120	600	2835SMD	165,90 €
LS12cw10XS	ca.1350	6000K	12VDC	10Watt	8,33mm	40	3	2,5cm	120	600	2835SMD	165,90 €



-20°C



+45°C



+55°C



3,5cm



-



IP20



120°

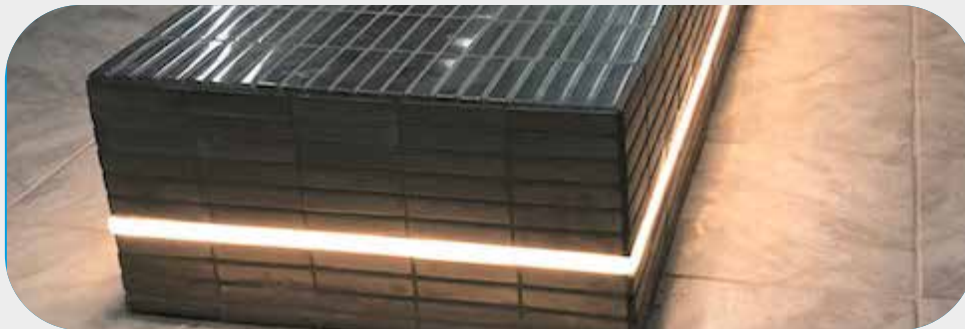

LED-Type 9,6 Watt/Meter



LED-Streifen Type 9,6Watt/Meter, flexible , IP20, RA>80, Abstrahlwinkel 120°, Dimmbar, 4x1,6x5000mm



gw ww nw cw



Artikel Nr.	lm/m	Lichtfarbe	VDC	W/m	Pitch	Segmete/ m	LED/Seg.	trennbar alle	LED/m	Led`s/ Rolle	Chip Type	Preis/ Rolle
LS24gw10XXS	ca.750	2400K	24VDC	9,6Watt	2,86mm	50	7	2cm	350	1750	2110SMD	185,90 €
LS24ww10XXS	ca.822	3000K	24VDC	9,6Watt	2,86mm	50	7	2cm	350	1750	2110SMD	185,90 €
LS24nw10XXS	ca.860	4000K	24VDC	9,6Watt	2,86mm	50	7	2cm	350	1750	2110SMD	185,90 €
LS24cw10XXS	ca.870	6000K	24VDC	9,6Watt	2,86mm	50	7	2cm	350	1750	2110SMD	185,90 €



-20°C



+45°C



+55°C



3,5cm



-



IP20



120°

LED-Lauflicht



LED-Streifen Type 25Watt/Meter, flexible , IP20, Abstrahlwinkel 120°, 10x1,6x5000mm

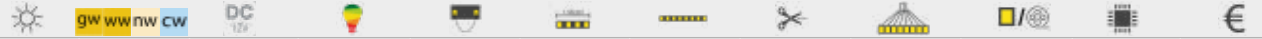

Artikel Nr.	lm/m	Lichtfarbe	VDC	W/m	Pitch	Segmete/ m	LED/Seg.	trennbar alle	LED/m	Led`s/ Rolle	Chip Type	Preis/ Rolle
LS05mcl44dig	ca.845	RGB	5VDC	25Watt	6,94mm	144	1	0,69cm	144	720	5050	239,90 €

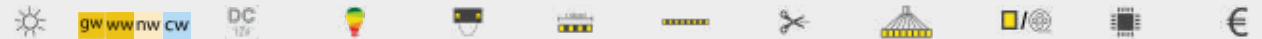

Artikel Nr.	lm/m	Lichtfarbe	VDC	W/m	Pitch	Segmete/ m	LED/Seg.	trennbar alle	LED/m	Led`s/ Rolle	Chip Type	Preis/ Rolle
LS05digmc		RGB	5VDC	19Watt	16,67mm	20	1	1,67cm	60	300	5050	199,95 €

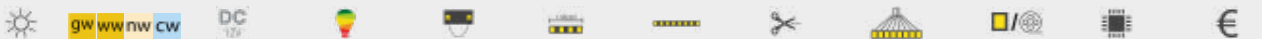

Artikel Nr.	lm/m	Lichtfarbe	VDC	W/m	Pitch	Segmete/ m	LED/Seg.	trennbar alle	LED/m	Led`s/ Rolle	Chip Type	Preis/ Rolle
LS05digmcww		RGB/W	5VDC	25Watt	16,67mm	20	1+1	1,67cm	2x60	600	5050 & 2835	259,80 €



NLMODST



Steuerung für Digitale LED-Streifen oder LED-Module 1 Kanal mit vorprogrammierten Szenen

67,80 €

NLMC-DIG



Steuerung für Digitale LED-Streifen oder LED-Module 1 Kanal Programmierbar

99,00 €

NLMC-DIG16



Steuerung für Digitale LED-Streifen oder LED-Module 16Kanal Programmierbar

519,90 €

auf Bestellung LED-Sonderstreifen

LED-Streifen für den direkten Anschluss An Wechselspannung (230VAC) 300 METER AM STÜCK

Ihre Professionelle Lösung für Hafen-Sicherheitsbeleuchtung.

Bis zu 300 Meter LED-Streifen am Stück ohne weitere Einspeisungen.

Die individuelle Fertigungsmöglichkeit dieses LED-Streifens ermöglicht Wunschlängen von LED-Streifen und Zuleitung (Zuleitung 50-500cm).

Die Transparente Silikonummantelung des Streifens bietet einen Schutz in IP65.

Die Durchschlagsfestigkeit liegt bei 2500VAC.

LED-Type 3 Watt/Meter

LED-Streifen Type 3Watt/Meter, flexible , IP65, RA>80, Abstrahlwinkel 120°, 14x8mm x10Meter bis 300 Meter



Artikel Nr.	lm/m	Lichtfarbe	VDC	W/m	Pitch	Segmete/ m	LED/Seg.	trennbar alle	LED/m	Led` s/ Rolle	Chip Type	Preis/m
LS230ww03AC	ca.250	3000K	230VAC	3Watt	16,67mm	40	60	100cm	60	60-21000	2835SMD	75,50 €
LS230nw03AC	ca.300	4000K	230VAC	3Watt	16,67mm	40	60	100cm	60	60-21001	2835SMD	75,50 €
LS230cw03AC	ca.330	6000K	230VAC	3Watt	16,67mm	40	60	100cm	60	60-21002	2835SMD	75,50 €



-20°C



+45°C



+55°C



3,5cm



-



IP20



120°



Achtung 230VAC am Anschluss!

Installation nur durch ausgebildetes Fachpersonal

auf Bestellung



LED-Sonderstreifen

Konstantstrom LED-Streifen bis 50m am Stück und einseitiger Einspeisung

Led Streifen 10m Lange

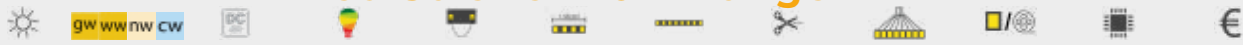

Artikel Nr.	lm/m	Lichtfarbe	VDC	W/m	Pitch	Segmete/ m	LED/Seg.	trennbar alle	LED/m	Led` s/ Rolle	Chip Type	Preis/ Rolle
LScc48ww10-10	ca.950	3000K	48VDC	10,5Watt	13,33mm	5	15	20cm	75	750	2835SMD	299,90 €
LScc48nw10-10	ca.1000	4000K	48VDC	10,5Watt	13,33mm	5	15	20cm	75	750	2835SMD	299,90 €
LScc48cw10-10	ca.1030	6000K	48VDC	10,5Watt	13,33mm	5	15	20cm	75	750	2835SMD	299,90 €

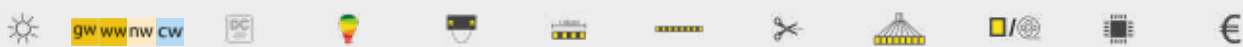
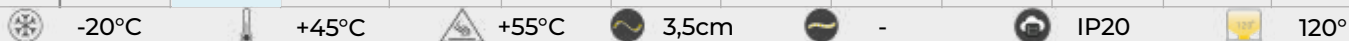

Artikel Nr.	lm/m	Lichtfarbe	VDC	W/m	Pitch	Segmete/ m	LED/Seg.	trennbar alle	LED/m	Led` s/ Rolle	Chip Type	Preis/ Rolle
LScc48ww13-10	ca.1250	3000K	48VDC	12,8Watt	6,67mm	10	15	10cm	150	1500	2835SMD	379,90 €
LScc48nw13-10	ca.1300	4000K	48VDC	12,8Watt	6,67mm	10	15	10cm	150	1500	2835SMD	379,90 €
LScc48cw13-10	ca.1330	6000K	48VDC	12,8Watt	6,67mm	10	15	10cm	150	1500	2835SMD	379,90 €

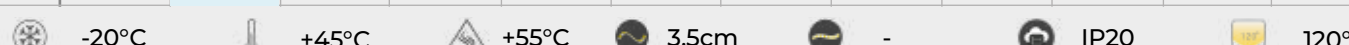

Led Streifen 20m Lange

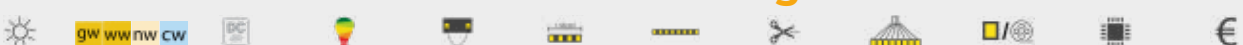

Artikel Nr.	lm/m	Lichtfarbe	VDC	W/m	Pitch	Segmete/ m	LED/Seg.	trennbar alle	LED/m	Led` s/ Rolle	Chip Type	Preis/ Rolle
LScc48ww12-20	ca950	3000K	48VDC	11,5Watt	14,28mm	5	14	20cm	70	1400	2835SMD	545,95 €
LScc48nw12-20	ca.1000	4000K	48VDC	11,5Watt	14,28mm	5	14	20cm	70	1400	2835SMD	545,95 €
LScc48cw12-20	ca.1030	6000K	48VDC	11,5Watt	14,28mm	5	14	20cm	70	1400	2835SMD	545,95 €

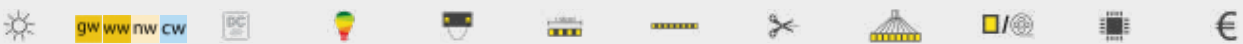

Artikel Nr.	lm/m	Lichtfarbe	VDC	W/m	Pitch	Segmete/ m	LED/Seg.	trennbar alle	LED/m	Led` s/ Rolle	Chip Type	Preis/ Rolle
LScc48ww13-20	ca.1150	3000K	48VDC	12,8Watt	7,14mm	10	14	10cm	140	1400	2835SMD	629,50
LScc48nw13-20	ca.1200	4000K	48VDC	12,8Watt	7,14mm	10	14	10cm	140	1400	2835SMD	629,50
LScc48cw13-20	ca.1230	6000K	48VDC	12,8Watt	7,14mm	10	14	10cm	140	1400	2835SMD	629,50

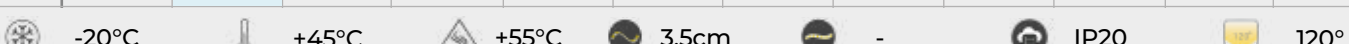

auf Bestellung



LED-Sonderstreifen

Konstantstrom LED-Streifen bis 50m am Stück und einseitiger Einspeisung

Led Streifen 30m Lange

Artikel Nr.	Im/m	Lichtfarbe	VDC	W/m	Pitch	Segmete/ m	LED/Seg.	trennbar alle	LED/m	Led`s/ Rolle	Chip Type	Preis/ Rolle
LScc48ww09-30	ca.725	3000K	48VDC	9Watt	15,38mm	5	13	20cm	65	1950	2835SMD	678,00 €
LScc48nw09-30	ca.750	4000K	48VDC	9Watt	15,38mm	5	13	20cm	65	1950	2835SMD	678,00 €
LScc48cw09-30	ca.780	6000K	48VDC	9Watt	15,38mm	5	13	20cm	65	1950	2835SMD	678,0 €

-20°C +45°C +55°C 3,5cm - IP20 120°

Artikel Nr.	Im/m	Lichtfarbe	VDC	W/m	Pitch	Segmete/ m	LED/Seg.	trennbar alle	LED/m	Led`s/ Rolle	Chip Type	Preis/ Rolle
LScc48ww13-30	ca.1050	3000K	48VDC	12,8Watt	7,69mm	10	13	10cm	130	3900	2835SMD	715,50 €
LScc48nw13-30	ca.1100	4000K	48VDC	12,8Watt	7,69mm	10	13	10cm	130	3900	2835SMD	715,50 €
LScc48cw13-30	ca.1140	6000K	48VDC	12,8Watt	7,69mm	10	13	10cm	130	3900	2835SMD	715,50 €

-20°C +45°C +55°C 3,5cm - IP20 120°

Led Streifen 40m Lange

Artikel Nr.	Im/m	Lichtfarbe	VDC	W/m	Pitch	Segmete/ m	LED/Seg.	trennbar alle	LED/m	Led`s/ Rolle	Chip Type	Preis/ Rolle
LScc48ww09-40	ca.360	3000K	48VDC	4Watt	15,38mm	5	13	20cm	65	2600	2835SMD	739,50 €
LScc48nw09-40	ca.400	4000K	48VDC	4Watt	15,38mm	5	13	20cm	65	2600	2835SMD	739,50 €
LScc48cw09-40	ca.380	6000K	48VDC	4Watt	15,38mm	5	13	20cm	65	2600	2835SMD	739,50 €

-20°C +45°C +55°C 3,5cm - IP20 120°

Artikel Nr.	Im/m	Lichtfarbe	VDC	W/m	Pitch	Segmete/ m	LED/Seg.	trennbar alle	LED/m	Led`s/ Rolle	Chip Type	Preis/ Rolle
LScc48ww13-40	ca.480	3000K	48VDC	5,8Watt	7,69mm	10	13	10cm	130	5200	2835SMD	768,50
LScc48nw13-40	ca.530	4000K	48VDC	5,8Watt	7,69mm	10	13	10cm	130	5200	2835SMD	768,50
LScc48cw13-40	ca.490	6000K	48VDC	5,8Watt	7,69mm	10	13	10cm	130	5200	2835SMD	768,50

-20°C +45°C +55°C 3,5cm - IP20 120°

auf Bestellung LED-Sonderstreifen



Konstantstrom LED-Streifen bis 50m am Stück und einseitiger Einspeisung

Led Streifen 50m Lange

Artikel Nr.	Im/m	Lichtfarbe	VDC	W/m	Pitch	Segmete/m	LED/Seg.	trennbar alle	LED/m	Led`s/Rolle	Chip Type	Preis/Rolle
LSc48ww03-50	ca.250	3000K	48VDC	3Watt	15,38mm	5	13	20cm	60	3250	2835SMD	889,90 €
LSc48nw03-50	ca.280	4000K	48VDC	3Watt	15,38mm	5	13	20cm	60	3250	2835SMD	889,90 €
LSc48cw03-50	ca.260	6000K	48VDC	3Watt	15,38mm	5	13	20cm	60	3250	2835SMD	889,90 €

-20°C +45°C +55°C 3,5cm - IP20 120°

Artikel Nr.	Im/m	Lichtfarbe	VDC	W/m	Pitch	Segmete/m	LED/Seg.	trennbar alle	LED/m	Led`s/Rolle	Chip Type	Preis/Rolle
LSc48ww04-50	ca.300	3000K	48VDC	4Watt	12,8mm	6	13	16,6cm	78	3900	3528SMD	929,90 €
LSc48nw04-50	ca.320	4000K	48VDC	4Watt	12,8mm	6	13	16,6cm	78	3900	3528SMD	929,90 €
LSc48cw04-50	ca.330	6000K	48VDC	4Watt	12,8mm	6	13	16,6cm	78	3900	3528SMD	929,90 €

-20°C +45°C +55°C 3,5cm - IP20 120°

Artikel Nr.	Im/m	Lichtfarbe	VDC	W/m	Pitch	Segmete/m	LED/Seg.	trennbar alle	LED/m	Led`s/Rolle	Chip Type	Preis/Rolle
LSc48ww05-50	ca.330	3000K	48VDC	4,2Watt	7,69mm	10	13	10cm	130	6500	2835SMD	965,50 €
LSc48nw05-50	ca.360	4000K	48VDC	4,2Watt	7,69mm	10	13	10cm	130	6500	2835SMD	965,50 €
LSc48cw05-50	ca.340	6000K	48VDC	4,2Watt	7,69mm	10	13	10cm	130	6500	2835SMD	965,50 €

-20°C +45°C +55°C 3,5cm - IP20 120°



Vollverguss

LED-Streifen, die in Aluminium- oder Silikonformen vergossen sind, bieten eine Vielzahl von Vorteilen für unterschiedliche Anwendungen. Diese Technologie kombiniert die Flexibilität von LED-Streifen mit der Haltbarkeit und Wärmeableitungsfähigkeit von Aluminium oder Silikon. Hier sind einige der wichtigsten Vorteile:

Schutz vor äußeren Einflüssen: Das Vergießen von LED-Streifen in Aluminium- oder Silikonformen bietet einen robusten Schutz vor Feuchtigkeit, Staub und mechanischen Beschädigungen. Dies erhöht die Lebensdauer der Streifen und ermöglicht den Einsatz in anspruchsvollen Umgebungen wie im Freien oder in feuchten Räumen.

Wärmeableitung: Aluminium ist ein hervorragender Wärmeleiter, während Silikon eine gute Wärmeisolierung bietet. Durch das Vergießen von LED-Streifen in diese Materialien wird die Wärme effizient von den LEDs

abgeleitet und gleichzeitig die Streifen vor Überhitzung geschützt. Dies verbessert die Leistung und Langlebigkeit der LEDs.

Flexibilität: LED-Streifen in Aluminium- oder Silikonformen sind oft flexibel und können leicht gebogen oder geformt werden, um sich verschiedenen Oberflächen anzupassen. Dies ermöglicht eine Vielzahl von Anwendungen, von der Beleuchtung von gebogenen Oberflächen bis hin zur Installation in engen Räumen.

Gleichmäßige Lichtverteilung: Die Vergussmaterialien sorgen für eine gleichmäßige Lichtverteilung entlang des gesamten Streifens, ohne Hotspots oder dunkle Bereiche. Dies führt zu einer homogenen Beleuchtung, die besonders in architektonischen Anwendungen oder bei der Hintergrundbeleuchtung von Displays wichtig ist.

Einfache Installation: LED-Streifen in Aluminium- oder Silikonformen sind oft mit Klebstoff oder Montageclips ausgestattet, die eine einfache Installation auf verschiedenen Oberflächen ermöglichen. Dies erleichtert die Integration in vorhandene Designs und reduziert die Installationszeit.

Insgesamt bieten LED-Streifen, die in Aluminium- oder Silikonformen vergossen sind, eine zuverlässige, flexible und langlebige Lösung für eine Vielzahl von Beleuchtungsanwendungen, von Wohnräumen über Gewerbegebäude bis hin zu architektonischen Projekten. Ihre Vielseitigkeit und Leistung machen sie zu einer attraktiven Option für Designer, Ingenieure und Heimwerker gleichermaßen.



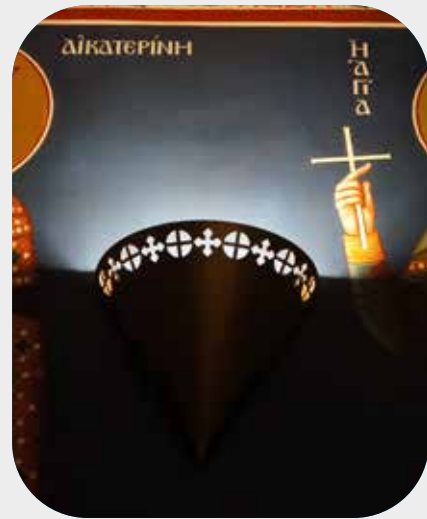

LED-Verbindungsstreifen

LSVS-4P



35,50 €/Rolle

Für die professionelle Verbindung zweier LED-Streifen, auch über Eck. Durch die beidseitige Leitungsführung, wird durch einfaches umklappen des Verbindungsstreifens, die gewünschte

Richtung bzw. der gewünschte Winkel eingestellt. Dann müssen die LED-Streifen nur noch mit dem Verbindungsstreifen verlötet werden.

LSVS-5P



49,90 €/Rolle

Eck-Lötverbinder

NLLEV-02

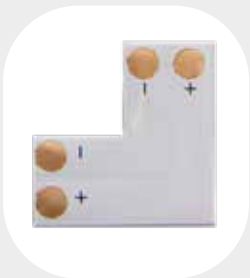

Löt-Eckverbinder für zweipolige LED-Streifen

4,95 €/Stk.

NLLEV-03



Löt-Eckverbinder für dreipolige LED-Streifen

4,95 €/Stk.

NLLEV-04



Löt-Eckverbinder für vierpolige LED-Streifen

5,20 €/Stk.

NLLEV-05



Löt-Eckverbinder für fünfpolige LED-Streifen

5,20 €/Stk.

T-Lötverbinder

NLLTV-02

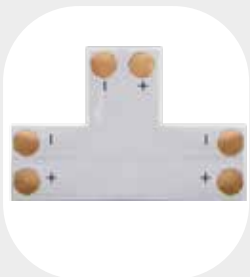

Löt-T-Verbinder für zweipolige LED-Streifen

5,15 €/Stk.

NLLTV-03



Löt-T-Verbinder für dreipolige LED-Streifen

5,15 €/Stk.

NLLTV-04



Löt-T-Verbinder für vierpolige LED-Streifen

5,40 €/Stk.

NLLTV-05



Löt-T-Verbinder für fünfpolige LED-Streifen

5,40 €/Stk.

Kreuz-Lötverbinder

NLLKV-02

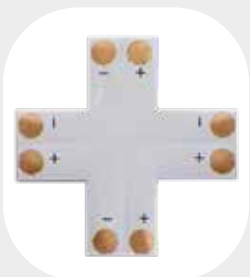

Löt-Kreuz-Verbinder für zweipolige LED-Streifen

5,50 €/Stk.

NLLKV-03

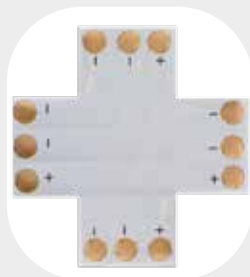

Löt-Kreuz-Verbinder für dreipolige LED-Streifen

5,50 €/Stk.

NLLKV-04

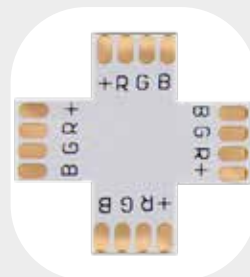

Löt-Kreuz-Verbinder für dreipolige LED-Streifen

5,90 €/Stk.

NLLKV-05

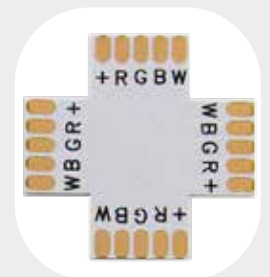

Löt-Kreuz-Verbinder für dreipolige LED-Streifen

5,90 €/Stk.

Kreuz-Lötverbinder

NLSCV-02



LED-Verbinder zweipolig.
Einfaches anklemmen
ohne löten. LED-
Streifen bis 10mm Breite
einfach einschieben.

BxHxL: 14,3x5x15mm
2,98 €/Stk.

NLSCV-03



LED-Verbinder dreipolig
Einfaches anklemmen
ohne löten. LED-
Streifen bis 10mm Breite
einfach einschieben.

BxHxL: 14,3x5x15mm
2,98 €/Stk.

NLSCV-04



LED-Verbinder vierpolig
Einfaches anklemmen
ohne löten. LED-
Streifen bis 10mm Breite
einfach einschieben.

BxHxL: 14,3x5x15mm
3,20€/Stk.

NLSCV-05



LED-Verbinder fünfpolig
Einfaches anklemmen
ohne löten. LED-
Streifen bis 10mm Breite
einfach einschieben.

BxHxL: 17x5x16mm
3,20€/Stk.

NLSCV-02T2



LED-Verbinder zweipolig
transparent.
Einfaches anklemmen
ohne löten. LED-
Streifen bis 10mm Breite
einfach einschieben und
einklemmen.

BxHxL: 14,5x7,5x19,5mm
4,50 €/Stk.

NLSCV-03T2



LED-Verbinder dreipolig
transparent.
Einfaches anklemmen
ohne löten. LED-
Streifen bis 10mm Breite
einfach einschieben und
einklemmen.

BxHxL: 14,5x7,5x19,5mm
4,50 €/Stk.

NLSCV-04T2



LED-Verbinder vierpolig
transparent.
Einfaches anklemmen
ohne löten. LED-
Streifen bis 10mm Breite
einfach einschieben und
einklemmen.

BxHxL: 14,5x7,5x19,5mm
4,98 €/Stk.

NLSCV-05T2



LED-Verbinder fünfpolig
transparent.
Einfaches anklemmen
ohne löten. LED-
Streifen bis 10mm Breite
einfach einschieben und
einklemmen.

BxHxL: 14,5x7,5x1mm
4,98 €/Stk.

NLSCV-02T3



LED-Verbinder zweipolig
transparent.
Einfaches anklemmen
ohne löten. LED-
Streifen bis 10mm Breite
einfach einschieben und
einklemmen. Kabel
einschieben und
festklemmen.

BxHxL: 14,5x7,5x1mm
4,50 €/Stk.

NLSCV-03T3



LED-Verbinder dreipolig
transparent.
Einfaches anklemmen
ohne löten. LED-
Streifen bis 10mm Breite
einfach einschieben und
einklemmen. Kabel
einschieben und
festklemmen.

BxHxL: 14,5x7,5x1mm
4,50 €/Stk.

NLSCV-04T3



LED-Verbinder vierpolig
transparent.
Einfaches anklemmen
ohne löten. LED-
Streifen bis 10mm Breite
einfach einschieben und
einklemmen. Kabel
einschieben und
festklemmen.

BxHxL: 14,5x7,5x1mm
4,98 €/Stk.

NLSCV-05T3



LED-Verbinder fünfpolig
transparent.
Einfaches anklemmen
ohne löten. LED-
Streifen bis 10mm Breite
einfach einschieben und
einklemmen. Kabel
einschieben und
festklemmen.

BxHxL: 14,5x7,5x1mm
4,98 €/Stk.

LED-Einspeise- Verbindungskabel

Einspeisekabel mit Klammer zum lötfreiem Verbindenden von LED-Streifen

NLSCK-02



Einspeisekabel
für zweipolige
LED-Streifen
5,30 €/Stk.

NLSCK-03



Einspeisekabel
für dreipolige
LED-Streifen
5,30 €/Stk.

NLSCK-04



Einspeisekabel
für vierpolige
LED-Streifen
5,50 €/Stk.

NLSCK-05

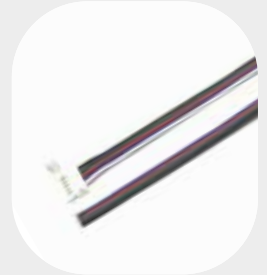

Einspeisekabel
für fünfpolige
LED-Streifen
5,50 €/Stk.

NLSCK-02



Einspeisekabel
für zweipolige
LED-Streifen
5,30 €/Stk.

NLSCK-03



Einspeisekabel
für dreipolige
LED-Streifen
5,30 €/Stk.

NLSCK-04



Einspeisekabel
für vierpolige
LED-Streifen
5,50 €/Stk.

NLSCK-05

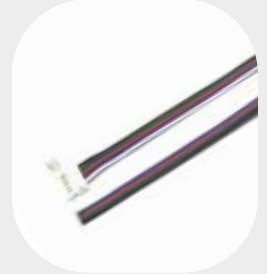

Einspeisekabel
für fünfpolige
LED-Streifen
5,50 €/Stk.

Verbindungskabel mit Klammern zu lötfreiem Verbindenden von LED-Streifen

NLSVK-02



Verbindungskabel
für zweipolige
LED-Streifen
5,50 €/Stk.

NLSVK-03



Verbindungskabel
für dreipolige
LED-Streifen
5,50 €/Stk.

NLSVK-04



Verbindungskabel
für vierpolige
LED-Streifen
5,70 €/Stk.

NLSVK-05



Verbindungskabel
für fünfpolige
LED-Streifen
5,70 €/Stk.

Abdeckungen und Zubehör für Aluminiumprofile



PAOP-01



PAKL-01



PAOP-011



PAOP-012



PAOP-02



PAOP-021



PAOP-03



PAOP-04



PAOP-05



PAOP-05a



PAOP-07



PAOP-071



PAOP-072



PAOP-08



PAOP-09

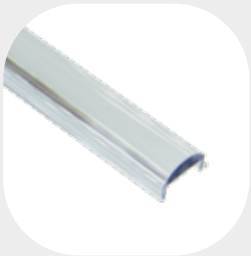

PALO-09

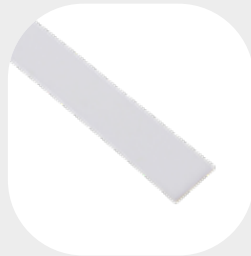

PAIL-09



PAGL-01



PAGL-02



PAGL-03



PARL-01



PARL-02



PARL-03



PARL-041



PARL-042



PAOPF-012



PAUGR-01OL



PAOPSSL-01



PAIOP-01



PAIOP-01mini

Montageklammern und Zubehör



PMK-01



PMK-02



PMK-03



PMK-04

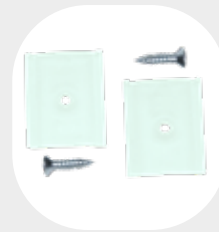

PMK-05



PMK-06



PMK-07



PMK-08



PMK-09



PMK-10



PMK-11



PMK-12



PMK-13



PMK-14



PMK4K-30



PMK4K-42

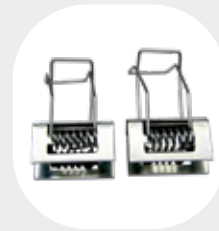

PMKMF-01



PMKMF-02



PMF-01

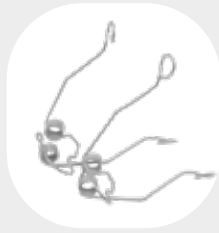

PMF-02



PMF-03



PMF-04

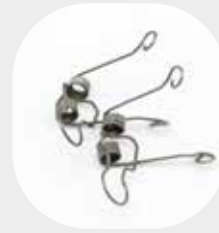

PMF-05

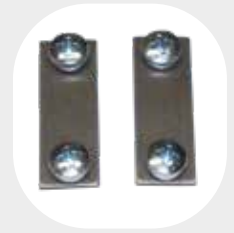

PV-00



PV-01



PV-02



PV-00s



PV-01s



PV-02s



PMPSP-01



PMPSP-02



NLPUNI-WH01



NLPUNI-WH02

Unser kompetentes Personal bietet Ihnen gerne anschlussfertige Muster an.
Die von Ihnen erstellte Zusammensetzung von Profil und LED-Streifen,
werden Ihnen Präsentationsfertig geliefert.

4K-Line

Design Profil mit vier Leuchtrichtungen.

Unsere 4K Profilvereihe ermöglicht Ihnen LED-Streifen individuell in vier Richtungen strahlen zu lassen. Sie können alle vier Kammern mit LED-Streifen bestücken und dabei ein Lumenpaket von bis >8000lm/Meter erzielen.

Durch den innenliegenden Kanal kann eine Zuleitung zu den jeweiligen Enden geführt werden, so dass auch längere Strecken über nur eine sichtbare Zuleitung betrieben werden können.

Gerne können wir Sie, in einem persönlichen Beratungsgespräch über die Vielseitigkeit dieses Profils und der Anwendungsbereiche beraten.

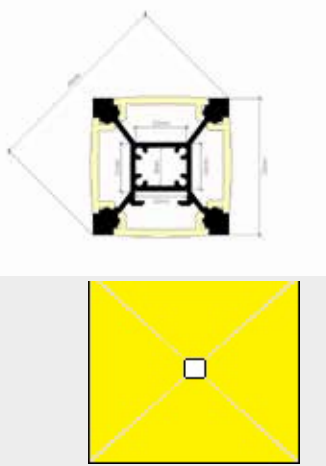

P4K-30s

Alu-eloxiert
Aluminium Design-Profil 4K-30
BxHxL: 32x32x2000mm

72,50 €/m

P4K-30w



Creme weiß
Aluminium Design-Profil 4K-30
BxHxL: 32x32x2000mm

72,50 €/m

P4K-30b

schwarz-eloxiert
Aluminium Design-Profil 4K-30
BxHxL: 32x32x2000mm

72,50 €/m

PAOP-04



Profil-Abdeckung 04,
opal für Nordstar
Aluminiumprofile
Lieferlänge 2000 oder
4000mm

11,60 €/m

PEK4K-30(x)

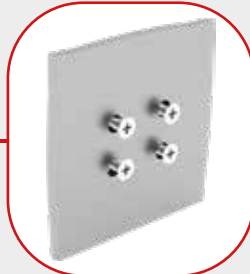

in sw oder b
Profilendkappe für
Aluminiumprofil
P4K-30 in den Farben alu,
schwarz und creme weiß

9,30 €/Stk.

PMK4K-30



Profil-Montageklammer
für P4K-30
mit Wandabstand, für die
einfachere
Installation

7,60 €/Stk.

PV-00s



Profil-Verbindungsele-
ment 00 small,
gerade

5,80 €/Stk.

PV-01s



Profil-Verbindungsele-
ment 01 small,
90° horizontal

5,80 €/Stk.

PV-02s

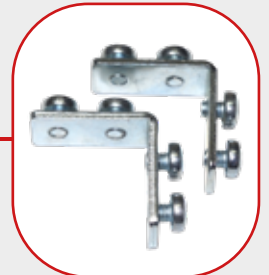

Profil-Verbindungsele-
ment 02 small,
90° vertikal

5,80 €/Stk.

Beleuchtungsmöglichkeiten

In unserem Anwendungsbeispiel wurden verschiedene LED-Streifen in unser Designprofil P4K-30 eingesetzt um eine individuelle Beleuchtung zu realisieren.

Die Kombination dieses Profils mit den LED-Streifen LS24nw15B (nach unten) und LS24nw10B (nach innen und nach aussen) haben bei den Abmessungen von 1000 x 500 mm ein Lumenpaket von bis zu 4600Lm/m und ca. 13800Lm pro Leuchte.

In den Beispielbildern wurden die Lichtvouten zusätzlich mit LED-Streifen LS24nw15B bestückt.



4K-Line

Design Profil mit vier Leuchtrichtungen.

Unser P4K-42 kann mit zwei verschiedenen Abdeckungsvarianten bestückt werden, wodurch verschiedene Anwendungsbereiche individuell gestaltet werden können.

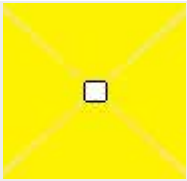
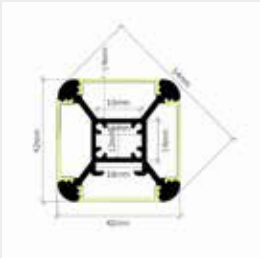

P4K-42s

Alu-eloxiert
Aluminium Design-Profil 4K-42
BxHxL: 42x42x2000mm

105,50 €/m

P4K-42w



Creme weiß
Aluminium Design-Profil 4K-42
BxHxL: 42x42x2000mm

105,50 €/m

P4K-42b

schwarz-eloxiert
Aluminium Design-Profil 4K-42
BxHxL: 42x42x2000mm

105,50 €/m

PAOP-02



Profil-Abdeckung 02, bündig zum Profil opal für Nordstar Aluminiumprofile Lieferlänge 2000 oder 4000mm

16,50 €/m

PAOP-021



Profil-Abdeckung 021, abstehend für weitere Lichtabstrahlung, opal für Nordstar Aluminiumprofile Lieferlänge 2000 oder 4000mm

32,95 €/m

PMK4K-42



Profil-Montageklammer für P4K-30 mit Wandabstand, für die einfachere Installation

8,20€/Stk.

PEK4K-42(x)



in s,w oder b Profilendkappe für Aluminiumprofil P4K-42 in den Farben alu, schwarz und creme-weiss.

9,30 €/Stk.

PEK4K-(011bis 016)(x)

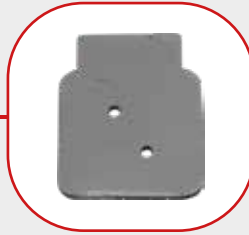

in s,w oder b Profilendkappe für Aluminiumprofil P4K-42 in den Farben alu, schwarz und Creme-weiss. Für verschiedene Abdeckungsvarian.

18,70 €/Stk.

PEK4K-(017bis 019)(x)



in s,w oder b Profilendkappe für Aluminiumprofil P4K-42 in den Farben alu, schwarz und Creme-weiss. Für verschiedene Abdeckungsvarian

20,90 €/Stk.

PV-00s



Profil-Verbindungselement 00 small, gerade

5,80 €/Stk.

PV-01s



Profil-Verbindungselement 01 small, 90° horizontal

5,80 €/Stk.

PV-02s



Profil-Verbindungselement 02 small, 90° vertikal

5,80 €/Stk.

Beleuchtungsmöglichkeiten

In unseren Anwendungsbeispielen wurden verschiedene Leuchten vom Designprofil P4K-42 gebaut. Diese wurden individuell in Grösse und Bestückung gefertigt. Durch die Bestückung der Leuchte mit LED-Streifen LS24nw30B (nach unten abstrahlend), LS24nw11B (nach aussen) und LS-24gw10B nach oben

wurde ein Lumenpaket von ca. 6000Lm/m und ca. 36000Lm insgesamt erzielt.

Ob als Hängeleuchte, Stehle, Seule, Spiegelleuchte, Bilderrahmen oder Kobus, die Profile P4K-30 und P4K-42 zeichnen sich durch die umfangreiche Anpassungsfähigkeit und die vielfältigen Einsatzmöglichkeiten für jeden Wunsch aus .

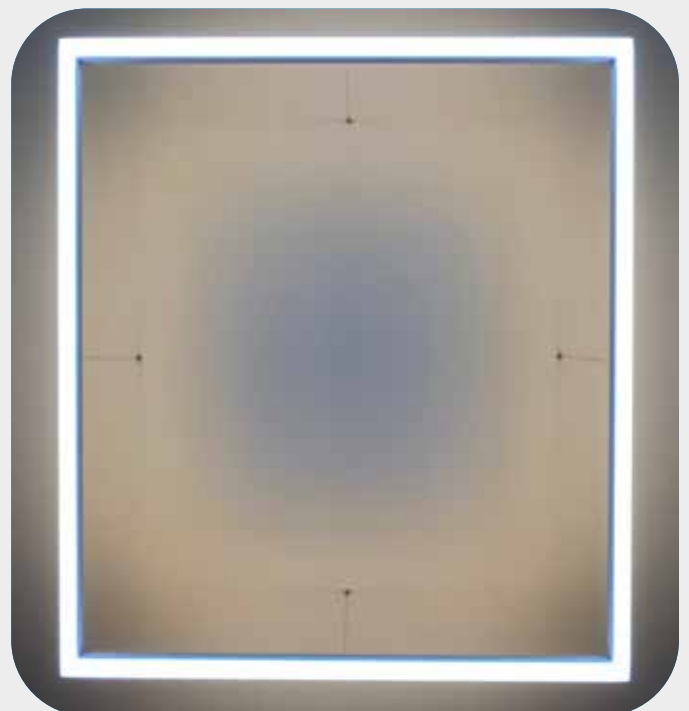
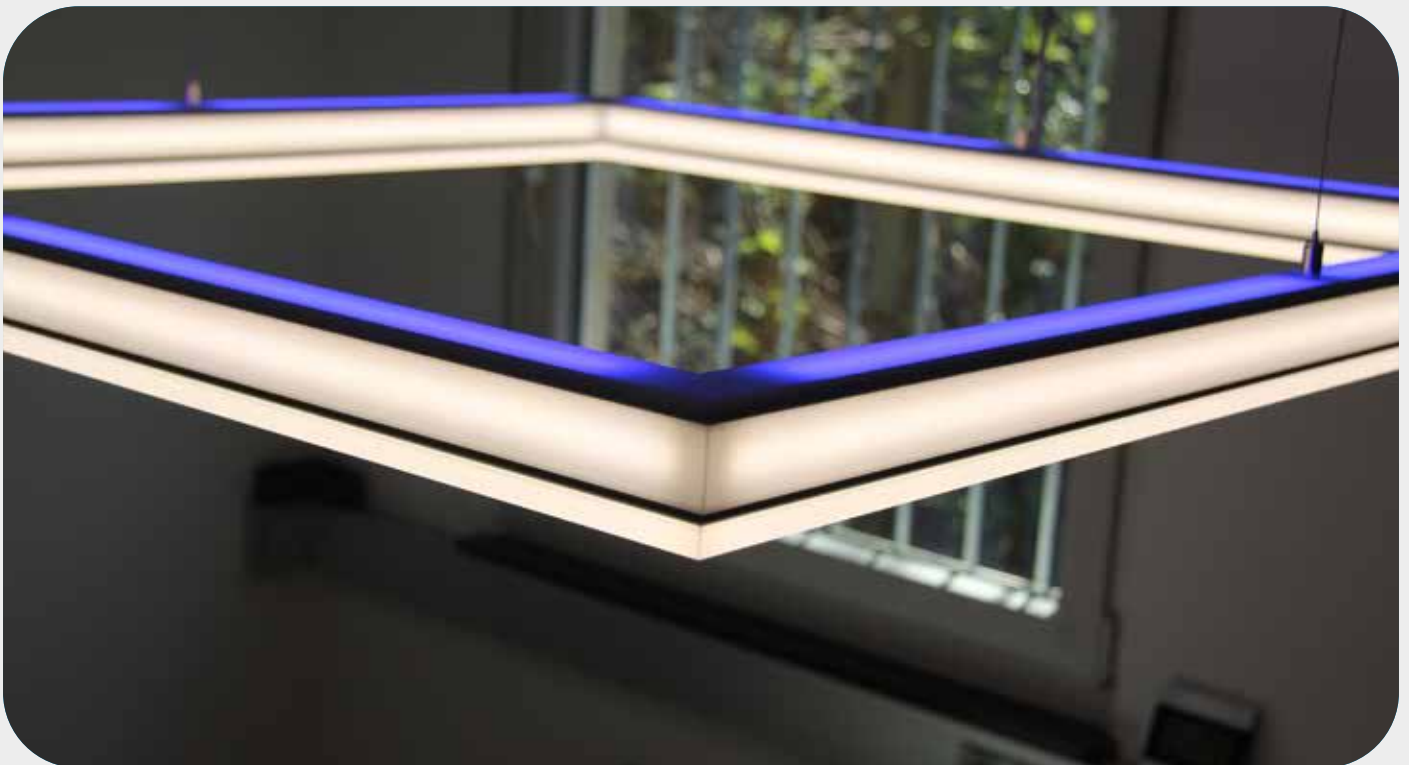

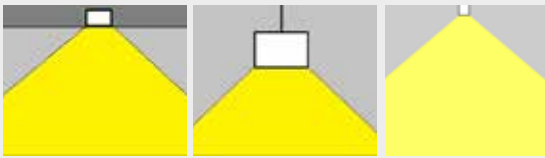

Star-Line

Star Line Aluminium Profile für LED-Streifen bis 15 Watt/Meter.
Ideale und unkomplizierte Montage von bis zu 12mm Breite LED-Streifen

PSL-01

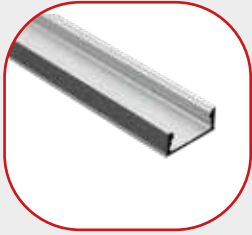

Star-Line 01 Aluminium-U-Profil alu-eloxiert.
BxHxL: 16,5x7x2000mm.
Innenmaß 13,5mm

8,50 €/m

PAOP-01



Profil Abdeckung Star-Line 01 opal für Aluminiumprofile der NORDSTAR Serien.
16,5x1x2000mm

8,50 €/m

PAKL-01



Profil Abdeckung Star-Line 01 klar für Aluminiumprofil der NORDSTAR Serien.
16,5x1x2000mm

8,50 €/m

PAOP-011

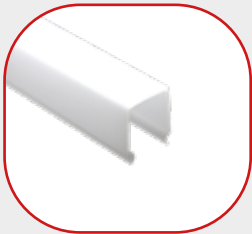

Profil Abdeckung Star-Line 011 opal für Aluminiumprofile der NORDSTAR Serien.
16,5x17x2000mm

15,95 €/m

PAOP-012



Profil Abdeckung Star-Line 012 opal für Aluminiumprofile der NORDSTAR Serien.
16,5x9x2000mm

20,40 €/Stk.

PMK-01



Montageklammer 01 aus Federstahl für NORDSTAR Aluminiumprofile inkl. Montageschraube

3,70 €/Stk.

PEKSL-01



Profil-Endkappe Star-Line 01 für Aluminiumprofil PSL-01 mit Abdeckung PAOP-01 oder PAKL-01
2,20 €/Stk.

PEKSL-011



Profil-Endkappe Star-Line 011 für Aluminiumprofil PSL-01 mit Abdeckung PAOP-011
3,30 €/Stk.

PEKSL-012



Profil-Endkappe Star-Line 012 für Aluminiumprofil PSL-01 mit Abdeckung PAOP-012
3,30 €/Stk.

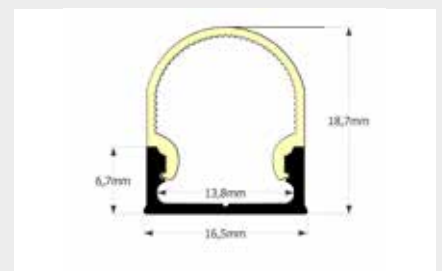
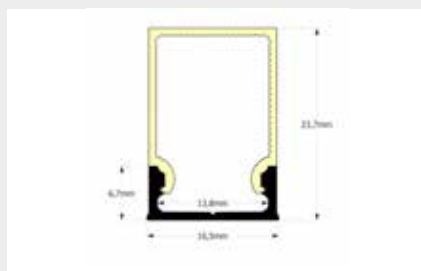
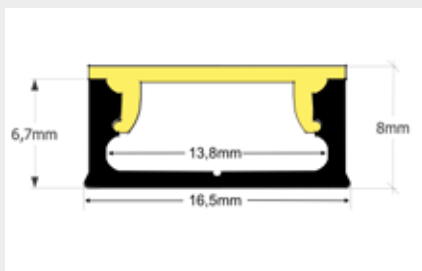

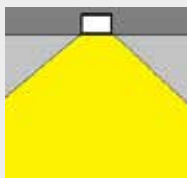

Star-Line

Star Line Aluminium Profil für LED-Streifen bis 15 Watt/Meter.
Ideale und unkomplizierte Montage von bis zu 12mm Breite LED-Streifen.

PSL-02



Star-Line 02
Aluminium-U-Profil
alu-eloxiert mit Kragen.
BxHxL: 16,5(24,5)x7x2000mm.
Innenmaß 13,5mm

8,50 €/m

PAOP-01



Profil Abdeckung Star-Line 01
opal für
Aluminiumprofile der
NORDSTAR Serien.
16,5x1x2000mm

8,50 €/m

PAKL-01



Profil Abdeckung Star-Line 01
klar für
Aluminiumprofil der
NORDSTAR Serien.
16,5x1x2000mm

8,50 €/m

POAP-011

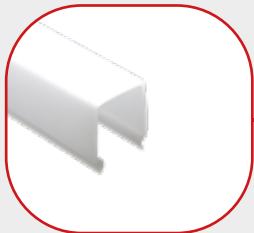

Profil Abdeckung Star-Line 011
opal für Aluminiumprofile der
NORDSTAR Serien.
16,5x17x2000mm

15,95 €/m

PAOP-012



Profil Abdeckung Star-Line 012 opal für
Aluminiumprofile der NORDSTAR
Serien.
16,5x9x2000mm

20,40 €/Stk.

PMK-01



Montageklammer 01 aus Federstahl
für NORDSTAR Aluminiumprofile
inkl. Montageschraube

3,70 €/Stk.

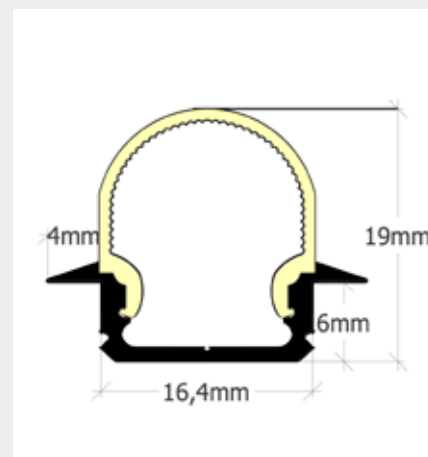
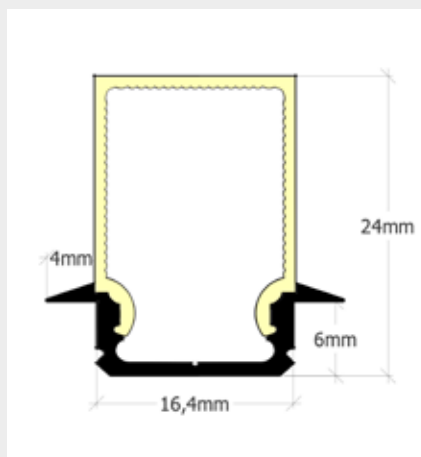
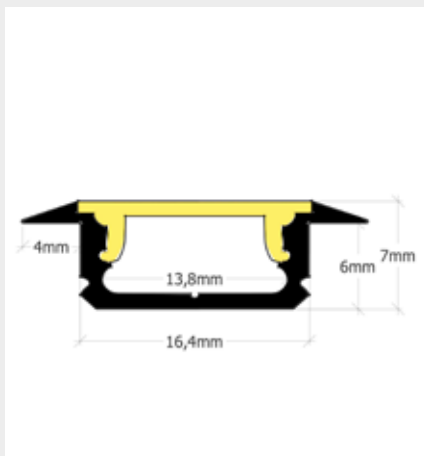

Star Line Aluminium Profile für LED-Streifen bis 15 Watt/Meter.
 Ideale und unkomplizierte Montage von bis zu 12mm Breite LED-Streifen.



PEKSL-02

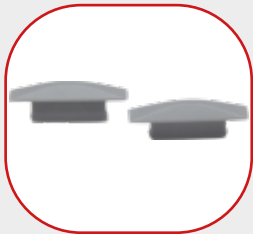

Profil-Endkappe Star-Line 02 für Aluminiumprofil PSL-02 mit Abdeckung PAOP-01 oder PAKL-01

2,20 €/Stk.

PEKSL-021



Profil-Endkappe Star-Line 021 für Aluminiumprofil PSL-02 mit Abdeckung PAOP-011

3,30 €/Stk.

PEKSL-022



Profil-Endkappe Star-Line 022 für Aluminiumprofil PSL-02 mit Abdeckung PAOP-012

3,30 €/Stk.

PMF-01

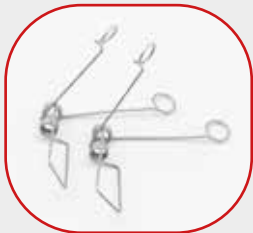

Feder 01 aus Federstahl für Hohlraummontage, für NORDSTAR Aluminiumprofile

6,60 €/Stk.

PMKMF-03

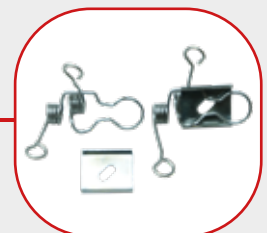

Montageklammer 01 aus Federstahl mit Feder 01 aus Federstahl für Hohlraummontage, für NORDSTAR Aluminiumprofile

12,60 €/Stk.

Star-Line

Star Line Aluminium Profile für LED-Streifen bis 15 Watt/Meter.
Ideale und unkomplizierte Montage von bis zu 12mm Breite LED-Streifen.

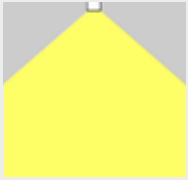

PSL-03



Star-Line 03
Aluminium-U-Profil
alu-eloxiert.
BxHxL: 16,5(24,5)x7x2000mm.
Innenmaß 13,5mm

10,70 €/m

PAOP-01



Profil Abdeckung Star-Line 01
opal für Aluminiumprofile der
NORDSTAR Serien.
16,5x1x2000mm

8,50 €/m

PAKL-01



Profil Abdeckung Star-Line 01
klar für Aluminiumprofil der
NORDSTAR Serien.
16,5x1x2000mm

8,50 €/m

POAP-011

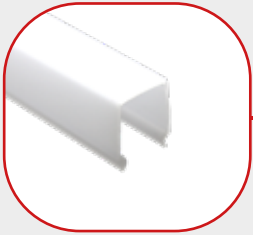

Profil Abdeckung Star-Line 011
opal für Aluminiumprofile der
NORDSTAR Serien.
16,5x17x2000mm

15,95 €/m

PAOP-012



Profil Abdeckung Star-Line 012 opal für
Aluminiumprofile der NORDSTAR
Serien.

16,5x9x2000mm

20,40 €/Stk.

PMK-01



Montageklammer 01 aus Federstahl
für NORDSTAR Aluminiumprofile
inkl. Montageschraube

3,70 €/Stk.

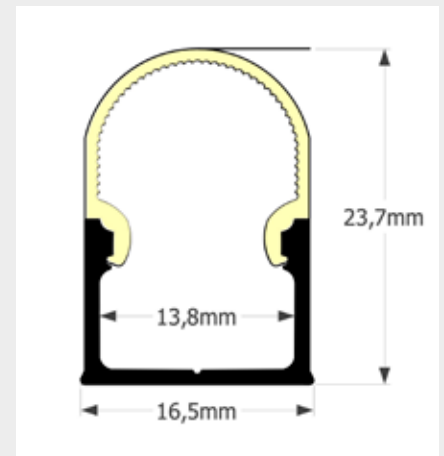
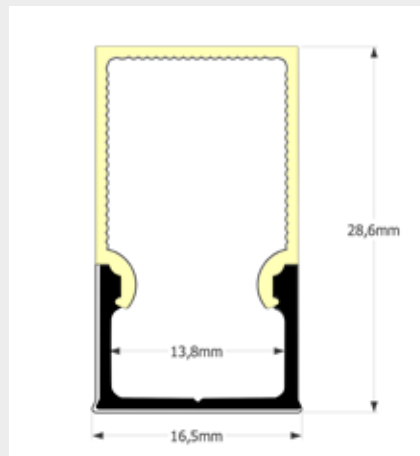
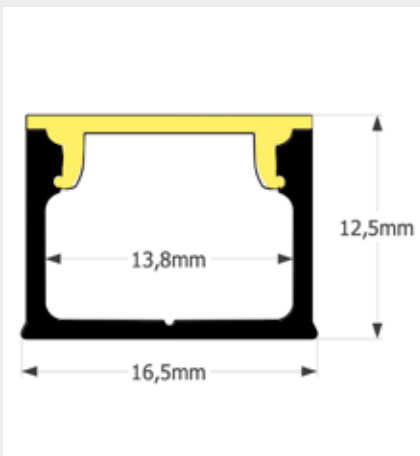

Star-Line

Star Line Aluminium Profile für LED-Streifen bis 15 Watt/Meter.
Ideale und unkomplizierte Montage von bis zu 12mm Breite LED-Streifen.



PEKSL-03



Profil-Endkappe Star-Line 03 für Aluminiumprofil PSL-03 mit Abdeckung PAOP-01 oder PAKL-01

2,60 €/Stk.

PEKSL-031



Profil-Endkappe Star-Line 31 für Aluminiumprofil PSL-03 mit Abdeckung PAOP-011

3,30 €/Stk.

PEKSL-032



Profil-Endkappe Star-Line 32 für Aluminiumprofil PSL-03 mit Abdeckung PAOP-012

3,30 €/Stk.

SPAOP-01



Profil-Silikonabdeckung SPAOP-01, ist eine opale, universale, für viele unserer Nordstar Profile einsetzbare Silikonabdeckung die gleichzeitig ultra flexibel ist. Das Material ist oberflächenbehandelt, sehr robust und gleichzeitig verschafft es ein homogenes Licht mit geringer Helligkeitsabsorbierung. Lieferlänge ab 2000mm bis 30000mm.

23,60 €/m

SPAOP-01p



Profil-Silikonabdeckung SPAOP-01p, ist eine opale, universale, für einige unserer Nordstar Profile einsetzbare Silikonabdeckung die gleichzeitig ultra flexibel ist und IP-Schutz bietet. Das Material ist oberflächenbehandelt, sehr robust und gleichzeitig verschafft es ein homogenes Licht mit geringer Helligkeitsabsorbierung. Lieferlänge ab 2000mm bis 30000mm

24,50 €/m

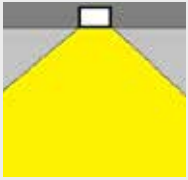

Star-Line

Star Line Aluminium Profile für LED-Streifen bis 15 Watt/Meter.
Ideale und unkomplizierte Montage von bis zu 12mm Breite LED-Streifen

PSL-04



Star-Line 04
Aluminium-U-Profil
alu-eloxiert mit Kragen.
BxHxL: 16,5(24,5)x12x2000mm.
Innenmaß 13,5mm

10,70 €/m

PSL-011

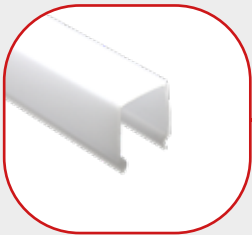

Profil Abdeckung Star-Line 011
opal für Aluminiumprofile der
NORDSTAR Serien.
16,5x17x2000mm

15,95 €/m

PAOP-01



Profil Abdeckung Star-Line 01
opal für Aluminiumprofile der
NORDSTAR Serien.
16,5x2000mm

8,50 €/m

PAOP-012



Profil Abdeckung Star-Line 012 opal für
Aluminiumprofile der NORDSTAR
Serien.
16,5x9x2000mm

20,40 €/Stk.

PAKL-01



Profil Abdeckung Star-Line 01
klar für Aluminiumprofile der
NORDSTAR Serien.
16,5x2000mm

8,50 €/m

PMK-01



Montageklammer 01 aus Federstahl
für NORDSTAR Aluminiumprofile
inkl. Montageschraube

3,70 €/Stk.

PSL-03 mit PAOP-01

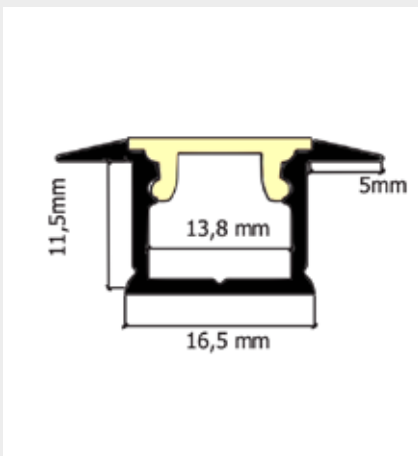

PSL-03 mit PAOP-011

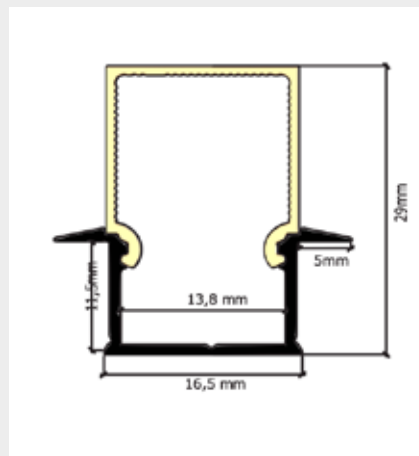

PSL-03 mit PAOP-012

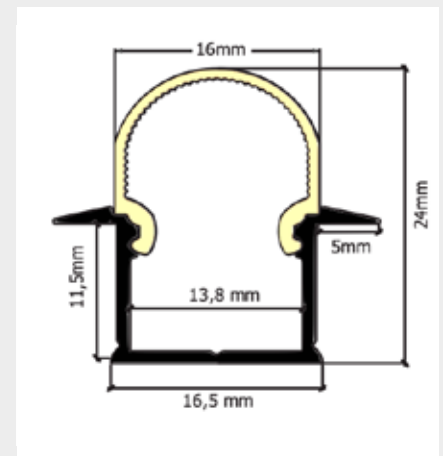

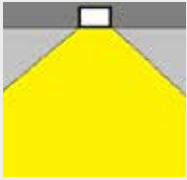

Star-Line

Star Line Aluminium Profile für LED-Streifen bis 15 Watt/Meter.
Ideale und unkomplizierte Montage von bis zu 12mm Breite LED-Streifen.



SPAOP-01

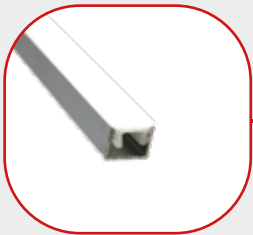

Profil-Silikonabdeckung SPAOP-01, ist eine opale, universale, für viele unserer Nordstar Profile einsetzbare Silikonabdeckung die gleichzeitig ultra flexibel ist. Das Material ist Oberflächenbehandelt, sehr robust und gleichzeitig verschafft es ein homogenes Licht mit geringer Helligkeitsabsorbierung. Lieferlänge ab 2000mm bis 30000mm.

23,60 €/m

PMF-01

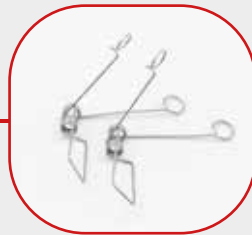

Feder 01 aus Federstahl für Hohlraummontage, für NORDSTAR Aluminiumprofile

6,60 €/Stk.

PMKMF-03



Montageklammer 01 aus Federstahl mit Feder 01 aus Federstahl für Hohlraummontage, für NORDSTAR Aluminiumprofile

12,60 €/Stk.

PEKSL-04



Profil-Endkappe Star-Line 04 für Aluminiumprofil PSL-04 mit Abdeckung PAOP-01 oder PAKL-01

2,60 €/Stk.

PEKSL-041



Profil-Endkappe Star-Line 041 für Aluminiumprofil PSL-04 mit Abdeckung PAOP-011

3,30 €/Stk.

PEKSL-042



Profil-Endkappe Star-Line 042 für Aluminiumprofil PSL-04 mit Abdeckung PAOP-012

3,30 €/Stk.

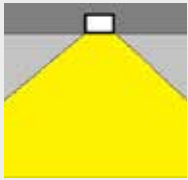

Star-Line

Star Line Aluminium Profile für LED-Streifen bis 15 Watt/Meter.
Ideale und unkomplizierte Montage von bis zu 12mm Breite LED-Streifen.

PSL-04F



Star-Line 01 Aluminium-U-Profil
alu-eloxiert.
BxHxL: 16,5x7x2000mm.
Innenmaß 13,5mm

10,95 €/m

PAOP-011

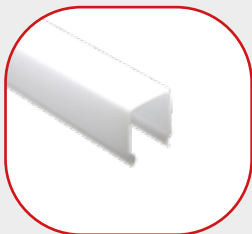

Profil Abdeckung Star-Line 011
opal für Aluminiumprofile der
NORDSTAR Serien.
16,5x17x2000mm

15,95 €/m

PEKSL-04F



Profil-Endkappe Star-Line 04F
für Aluminiumprofil PSL-04F
mit Abdeckung
PAOP-01 oder PAKL-01

2,60 €/Stk.

PAOP-01



Profil Abdeckung Star-Line 01
opal für Aluminiumprofile der
NORDSTAR Serien.
16,5x1x2000mm

8,50 €/m

PAOP-012



Profil Abdeckung Star-Line 012 opal für
Aluminiumprofile der NORDSTAR
Serien.

16,5x9x2000mm

20,40 €/Stk.

PEKSL-041F



Profil-Endkappe Star-Line
041F für Aluminiumprofil
PSL-04F mit Abdeckung
PAOP-011

3,30 €/Stk.

PAKL-01



Profil Abdeckung Star-Line 01
klar für Aluminiumprofil der
NORDSTAR Serien.
16,5x1x2000mm

8,50 €/m

PMF-01



Feder 01 aus Federstahl für
Hohlraummontage, für NORDSTAR
Aluminiumprofile

6,50 €/Stk.

PEKSL-042F



Profil-Endkappe Star-Line
042F für Aluminiumprofil
PSL-04F mit Abdeckung
PAOP-012

3,30 €/Stk.

SPAOP-01



Profil-Silikonabdeckung SPAOP-01, ist eine opale, universale,
für viele unserer Nordstar Profile einsetzbare Silikonabdeckung die
gleichzeitig ultra flexibel ist. Das Material ist oberflächenbehandelt,
sehr robust und gleichzeitig verschafft es ein homogenes Licht
mit geringer Helligkeitsabsorbierung. Lieferlänge ab 2000mm bis
30000mm.

23,60 €/m

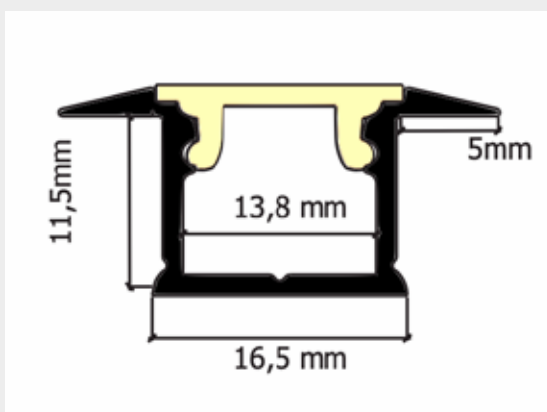

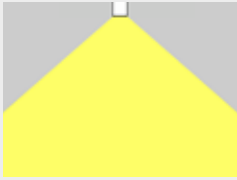

Star Line Aluminium Profile für LED-Streifen bis 24 Watt/Meter.
Ideale und unkomplizierte Montage von bis zu 18mm Breite LED-Streifen.



PSL-05



Star-Line 05
Aluminium-H-Profil
alu-eloxiert.
BxHxL: 22,5x12,6x2000mm.
Innenmaß 18,6mm
18,60 €/m

PAOP-04



Profil-Abdeckung 04, opal
für Nordstar Aluminiumprofile
Lieferlänge 2000 oder 4000mm
11,60 €/m

PMK-05

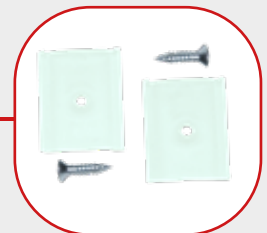

Montageklammer 05 aus
Kunststoff für NORDSTAR
Aluminiumprofile
inkl. Montageschraube
3,70 €/Stk.

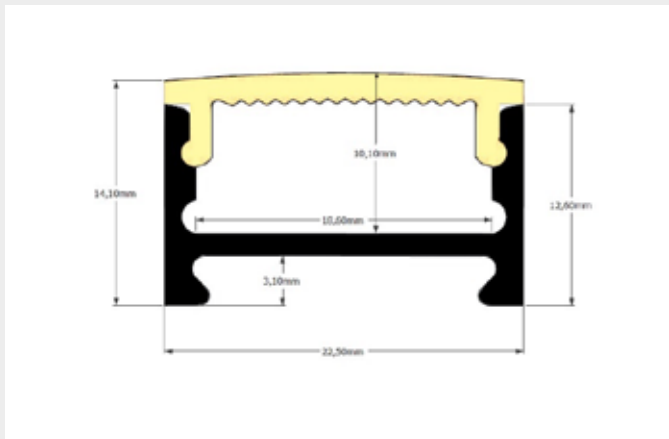

PEKSL-05



Profil-Endkappe Star-Line 05
für Aluminiumprofil PSL-05 mit
Abdeckung PAOP-04
2,80 €/Stk.

Star-Line



Star Line Aluminium Profile für LED-Streifen bis 30 Watt/Meter.
Ideale und unkomplizierte Montage von bis zu 18mm Breite LED-Streifen.

PSL-06



Star-Line 06
Aluminium-H-Profil
alu-eloxiert.
BxHxL: 22,5x25x2000mm.
Innenmaß 18,6mm

20,50 €/m

PAOP-04



Profil-Abdeckung 04, opal
für Nordstar Aluminiumprofile
Lieferlänge 2000 oder 4000mm

11,60 €/m

PMK-05

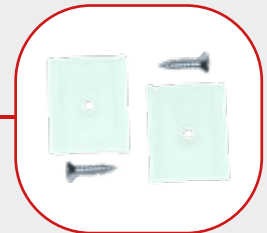

Montageklammer 05 aus
Kunststoff für NORDSTAR
Aluminiumprofile
inkl. Montageschraube

3,70 €/Stk.

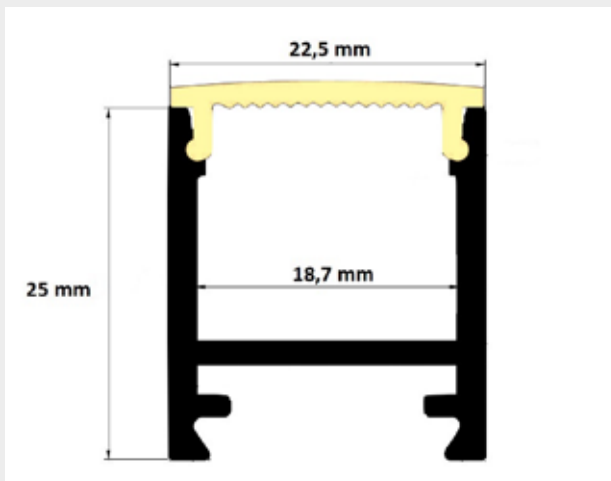

PEKSL-06



Profil-Endkappe Star-Line 06
für Aluminiumprofil PSL-06 mit
Abdeckung PAOP-04

3,30 €/Stk.

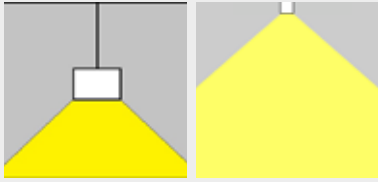

High Frozen Line

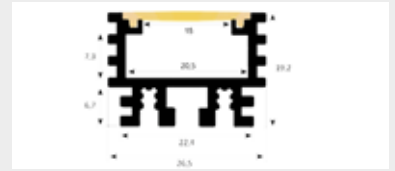

PHF-01s



High-Frozen-Line 01
Aluminium-U-Profil
alu-eloxiert
BxHxL: 26,5x19,2x2000mm

26,95 €/m

PHF-01b



High-Frozen-Line 01
Aluminium-U-Profil
schwarz-eloxiert
BxHxL: 26,5x19,2x2000mm

28,10 €/m

PAOPL-02

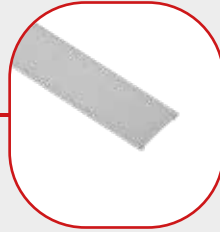

Profil-Abdeckung
L02 in opal

13,80 €/m

PAKLL-02



Profil-Abdeckung
L02 in klar

13,80 €/m

PABLL-02



Profil-Abdeckung
L02 in schwarz

13,80 €/m

PALOL-02



Profil-Abdeckung
L02 in Linsenoptic

15,95 €/m

PAOPL-021



Profil-Abdeckung
L021 (hohe Abdeckung)
in opal

18,20 €/m

PABLL-021



Profil-Abdeckung L021
(hohe Abdeckung)
in schwarz

18,20 €/m

PEKHF-01s



Endkappe High Frosen 01s,
alu-eloxiert für PHL-01 mit
Abdeckung L-02

6,60 €/Stk.

PEKHF-01b



Endkappe High Frosen 01b,
schwarz-eloxiert für PHL-01
mit Abdeckung L-02

6,60 €/Stk.

PEKHF-011s

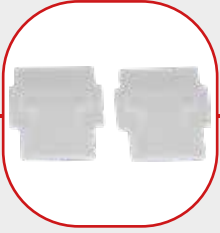

Endkappe High Frosen 011s,
alu-eloxiert für PHL-01 mit
Abdeckung L-021

7,20 €/Stk.

PEKHF-011b



Endkappe High Frosen 011b,
schwarz-eloxiert für PHL-01
mit Abdeckung L-021

7,20 €/Stk.

PMK-18s

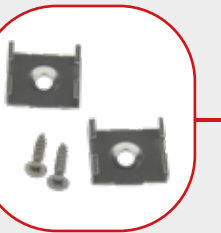

Montageclip 18
alu-eloxiert

3,70 €/Stk.

PMK-18b

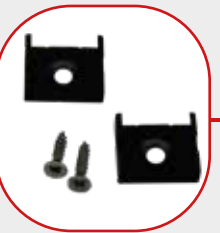

Montageclip 18
schwarz-eloxiert

3,70 €/Stk.

PVL-01



Profilverbinder
L-01, gerade.

10,80 €/Stk.

PVL-02



Profilverbinder
L-02, 90° horizontal.

11,60 €/Stk.

PVL-04

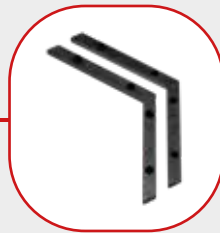

Profilverbinder L-04,
120° horizontal.

11,60 €/Stk.

Profi-Gips-Line

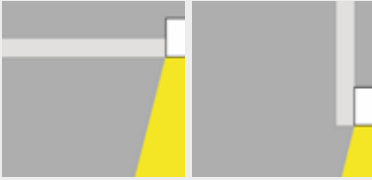

PRGL-01

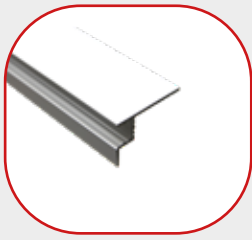

Profi-Rigips-Line 01
Aluminium-U-Profil
alu-eloxiert.
BxHxL: 27,2x43x2000mm

30,80 €/m

PAOP-01



Profil Abdeckung Star-Line 01
opal für Aluminiumprofile der
NORDSTAR Serien.
16,5x1x2000mm

8,50 €/m

PAKL-01



Profil Abdeckung Star-Line 01
klar für Aluminiumprofil der
NORDSTAR Serien.
16,5x1x2000mm

8,50 €/m

PAOP-011

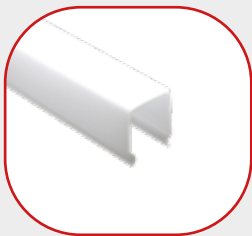

Profil Abdeckung Star-Line 011
opal für Aluminiumprofile der
NORDSTAR Serien.
16,5x17x2000mm

15,95 €/m

PAOP-012



Profil Abdeckung Star-Line 012 opal
für Aluminiumprofile der
NORDSTAR Serien.
16,5x9x2000mm

20,40 €/Stk.

PEKRG-01 (Set)



Profil-Endkappe Rigips-Line 01 für
Aluminiumprofil PRGL01
mit Abdeckung PAOP-01 oder
PAKL-01

21,85 €/Set.

PEKRG-011 (Set)



Profil-Endkappe Rigips-Line 011
für Aluminiumprofil PRGL01
mit Abdeckung PAOP-011

21,85 €/Set

SPAOP-01



Profil-Silikonabdeckung SPAOP-01, ist eine opale, universale, für viele unserer NordstarProfile einsetzbare Silikonabdeckung die gleichzeitig ultra flexibel ist. Das Material ist oberflächenbehandelt, sehr robust und gleichzeitig verschafft es ein homogenes Licht mit geringer Helligkeitsabsorbierung. Lieferlänge ab 2000mm bis 30000mm.

23,60 €/m

PEKRG-012 (Set)



Profil-Endkappe Rigips-Line
012 für Aluminiumprofil
PRGL01 mit Abdeckung
PAOP-012

21,85 €/Set

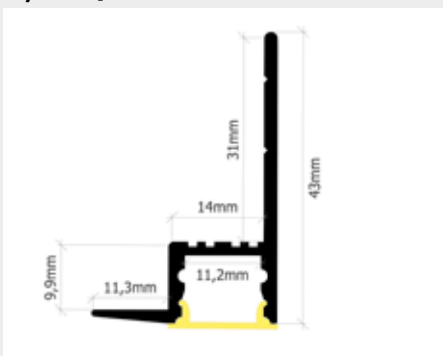



Profi-Gips-Line

PRGL-02



Profi-Rigips-Line 02
Aluminium-U-Profil
alu-eloxiert.
BxHxL: 60,6x26,4x3000mm

63,30 €/m

PAOPL-01



Profil Abdeckung L-01 opal für
Aluminiumprofile der
NORDSTAR Serien.

9,20 €/m

PEKRGL-02

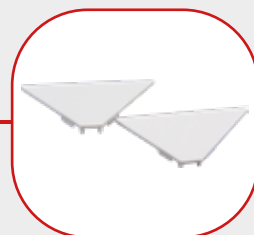

Profil Endkappe
Profi-Gips-Line 02
für Aluminiumprofil PRGL-02

5,80 €/Stk.

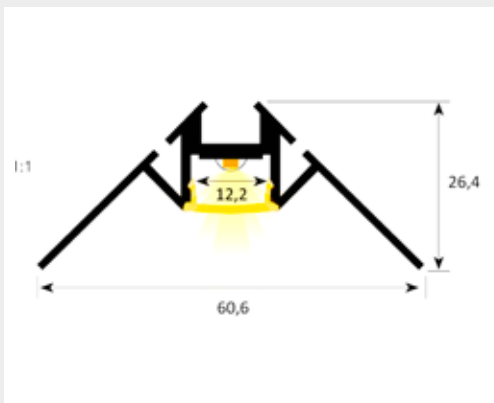

PRGL-03



Profi-Rigips-Line 03
Aluminium-U-Profil
alu-eloxiert.
BxHxL: 45,1x30,3x3000mm

61,10 €/m

PAOPL-01

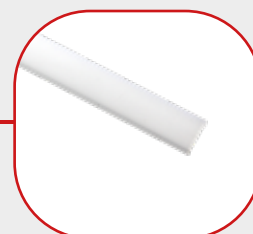

Profil Abdeckung L-01 opal für Alumi-
niumprofile der
NORDSTAR Serien.

9,20 €/m

PEKRGL-03



Profil Endkappe
Profi-Gips-Line 03
für Aluminiumprofil PRGL-03

5,80 €/Stk.

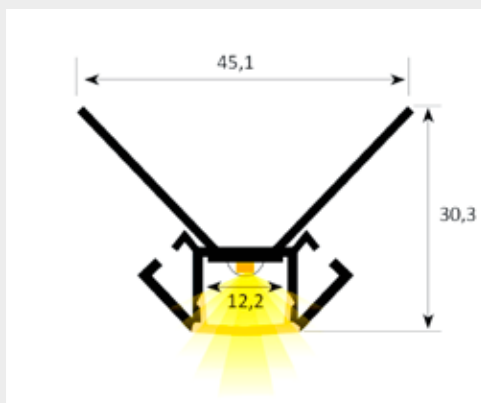

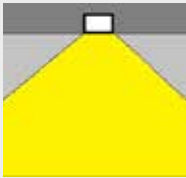

Profi-Gips-Line

PRGL-04



Profi-Rigips-Line 04
Aluminium-U-Profil
alu-eloxiert.
BxHxL: 28,5x14x3000mm

63,30 €/m

PAOPL-05



Profil Abdeckung L-05opal.

16,50 €/m

PEKRGL-04



Profil-Endkappe Rigips-Line 04
für Aluminiumprofil PRGL-04

5,80 €/m

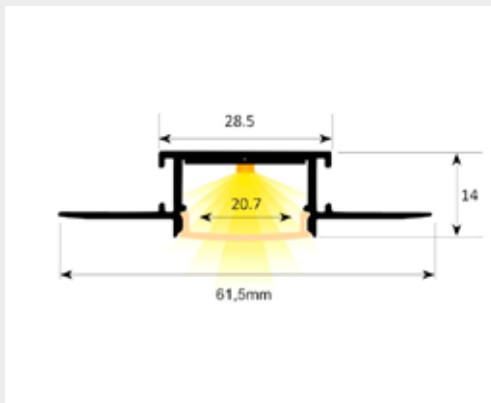

PRGL-08



Profi-Rigips-Line 08
Aluminium-Profil
weiß.
BxHxL: 94,4x34,5x2000mm

79,90 €/m

PAOPL-07



Profil Abdeckung L-07 opal für
Aluminiumprofile der NORDSTAR
Serien.

20,90 €/Stk.

PEKRGL-03

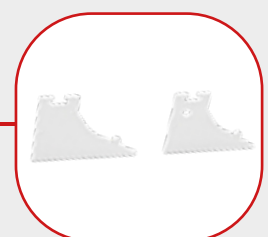

Profil-Endkappenset Rigips-Line 08
für
Aluminiumprofil PRGL-08

24,00 €/Set.

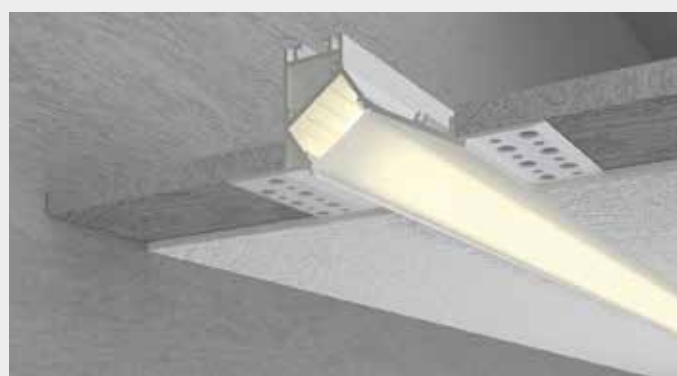
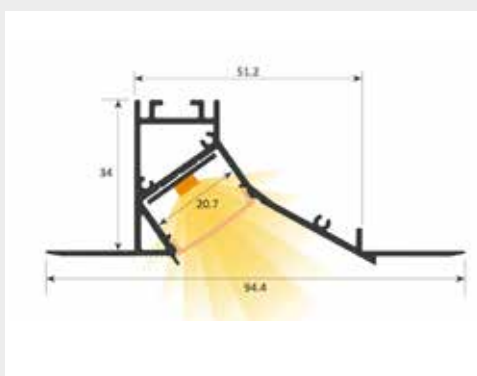

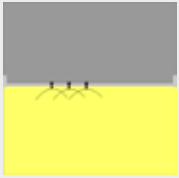

Wardrobe-Cloakroom-Line

PWCL-01

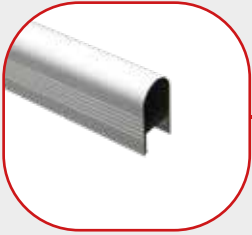

Wardrobe-Cloakroom
Aluminium-Profil alu-eloxiert
BxHxL: 15x28,15x2000mm

22,95 €/m

PAOP012



Profil Abdeckung Star-Line 012
opal für Aluminiumprofile der
NORDSTAR Serien. 2000mm

20,40 €/m.

PAOP-01



Profil Abdeckung Star-Line 01 opal
für Aluminiumprofile der NORDSTAR
Serien. 2000mm

8,50 €/m.

PAKL-01



Profil Abdeckung Star-Line 01 klar für
Aluminiumprofile der NORDSTAR
Serien. 2000mm

8,50 €/Stk.

PEKWCL-01



Profil-Endkappe
Wardrobe-Cloakroom Line 012
für Aluminiumprofil PWCL-01
mit Abdeckung PAOP-012

21,90 €/Set.

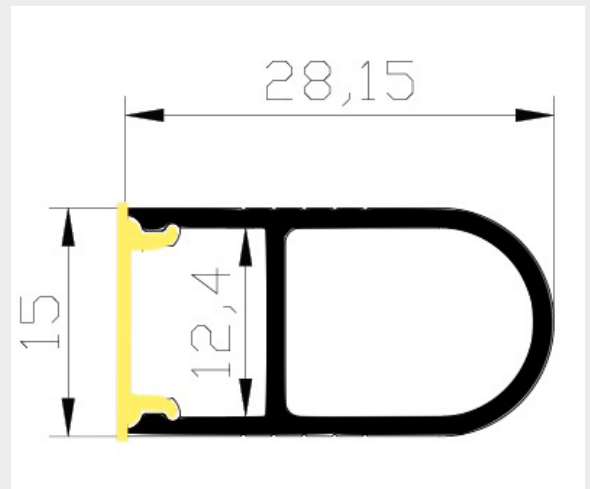

Ground Line

PGL-01



Ground-Line 01
Aluminium-U-Profil alu-eloxiert
BxHxL: 33x13x2000mm

25,50 €/m

PAGL-01



Profil Abdeckung Ground-Line 01 opal,
5mm stark, für Aluminiumprofile
PGL-01 u. PGL-02. 2000mm

38,50 €/Stk.

PEKGL-01



Profil-Endkappe Ground-Line 01 für
Aluminiumprofil PGL-01

6,10 €/Stk.

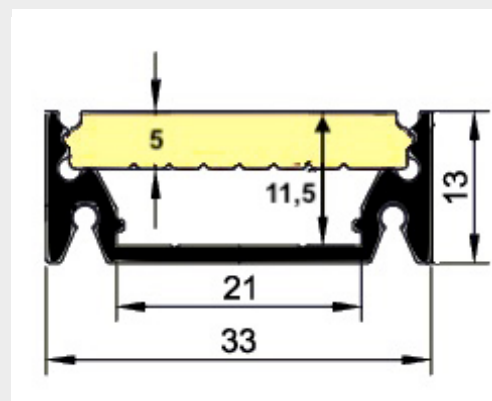
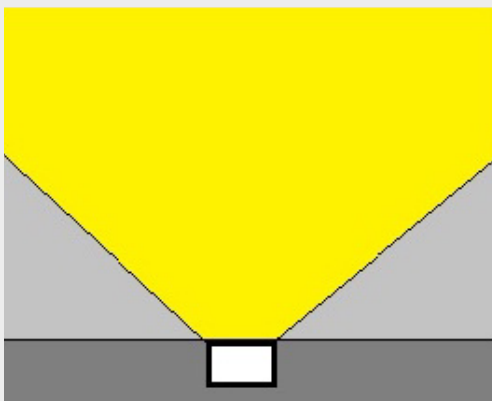

Ground Line

PGL-02



Ground-Line 02
Aluminium-U-Profil alu-eloxiert.
BxHxL: 33(41)x13x2000mm

25,50 €/m

PAGL-01



Profil Abdeckung Ground-Line 01 opal,
5mm stark, für Aluminiumprofile
PGL-01 u. PGL-02. 2000mm

38,50 €/m.

PEKGL-02

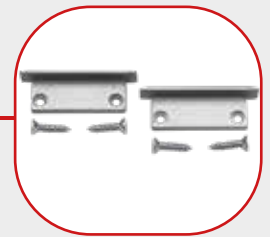

Profil-Endkappe Ground-Line 02 für
Aluminiumprofil PGL-02

6,10 €/Stk.

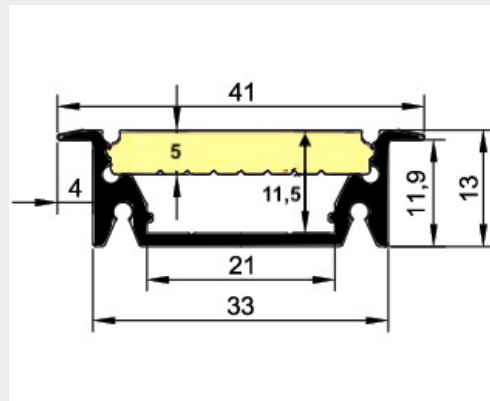
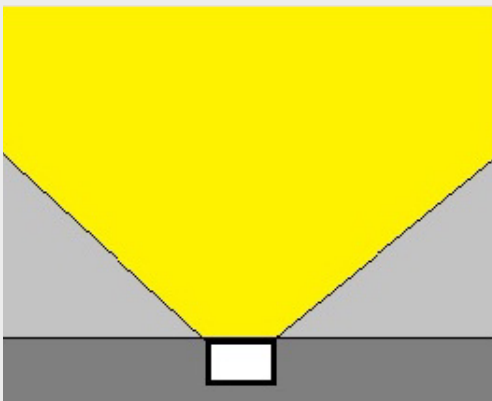

Ground Line

PGL-03sA u. PGL-03sB



Ground-Line 03s Trittstufenprofil und Abdeckprofil, alu-eloxiert.
BxHxL: 59x20x2000mm
(Zweiteilig)
96,70 €/m

PGL-03bA u. PGL-03bB

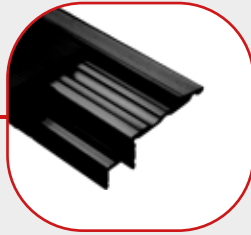

Ground-Line 03b Trittstufenprofil und Abdeckprofil, schwarz-eloxiert.
BxHxL: 59x20x2000mm
(Zweiteilig)
96,70 €/m.

PAOP-01



Profil Abdeckung Star-Line 01 opal für Aluminiumprofile der NORDSTAR Serien. 2000mm
8,50 €/m.

PAKL-01



Profil Abdeckung Star-Line 01 klar für Aluminiumprofil der NORDSTAR Serien. 2000mm
8,50 €/m.

SPAOP-01



Silikon-Abdeckung Star-Line 01 für Aluminiumprofile der NORDSTAR Serien.
23,60 €/m.

PEKGL-03



Profil-Endkappe Ground-Line 03 für Aluminium-Trittstufen-Profil
14,30 €/Stk.

PEKGL-03B



Profil-Endkappe Ground-Line 03B für Aluminium-Trittstufen-Profil
14,30 €/Stk.

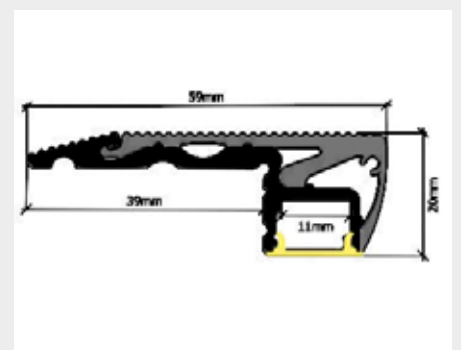
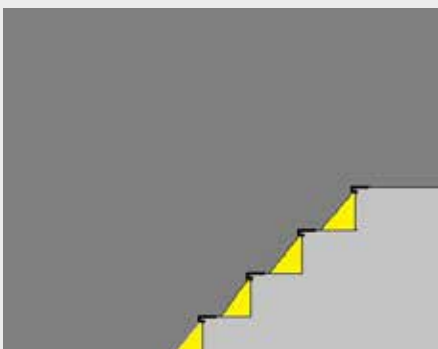

Ground Line

Trittstufenprofil mit zwei Anwendungsmöglichkeiten

PGL-04s



Ground-Line 04
Trittstufenprofil, alu-eloxiert.
BxHxL: 41,5x20,6x2000mm

31,40 €/m

PGL-04b



Ground-Line 04 Trittstufenprofil,
schwarz eloxiert. BxHxL:
41,5x20,6x2000mm

31,40 €/m

PAOP-09

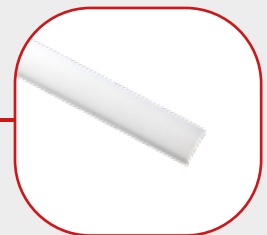

Profil-Abdeckung 09 opal.
2000mm

7,60 €/m

PPAGL-04s



Aluminium Profilabdeckung
für Frontmontage. Alu-eloxiert
2000mm

10,50 €/m

PPAGL-04b



Aluminium Profilabdeckung für
Frontmontage. Schwarz-eloxiert
2000mm

10,50 €/Stk.

PEKGL-04s

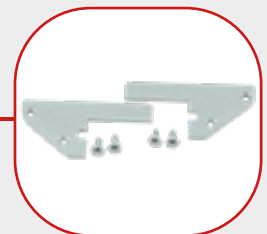

Endkappenset für Ground-Line 04s.
Alu-eloxiert

10,80 €/Stk.

PEKGL-04b



Endkappenset für Ground-Line
04s. Schwarz-eloxiert

10,80 €/Stk.

PARGL-04T



Transparentes
Antirutsch-Gummi 1000mm

3,90 €/Stk.

PARGL-04B



Schwarzes Antirutsch-Gummi
1000mm

3,90 €/Stk.

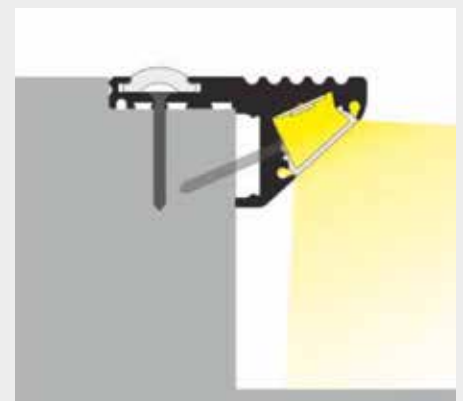
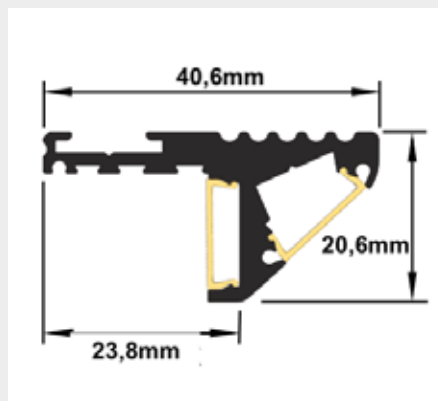

Ground Line

PGL-05.12



Aluminium Profil Ground-Line 05.11, Trittstufen-Profil messing zum Einsatz in Fliesen/Perkettstufen BxHxL: 146x15,3x1100mm.

109,95 €/m

PGL-05.16

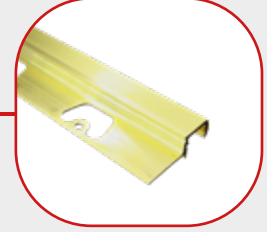

Aluminium Profil Ground-Line 05.11, Trittstufen-Profil messing zum Einsatz in Fliesen/Perkettstufen BxHxL: 146x15,3x1600mm.

149,00 €/m

PAOP-09

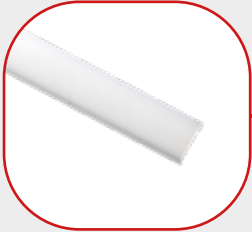

Profil-Abdeckung PAOP-09
2000mm

7,60 €/m

PEKGL-05

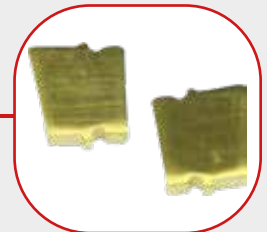

Endkappenset für Ground-Line 05.
Messing

9,40 €/Stk.

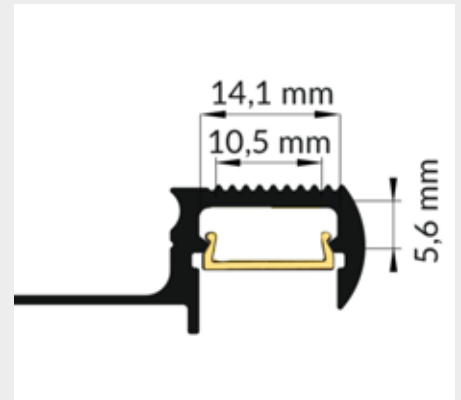
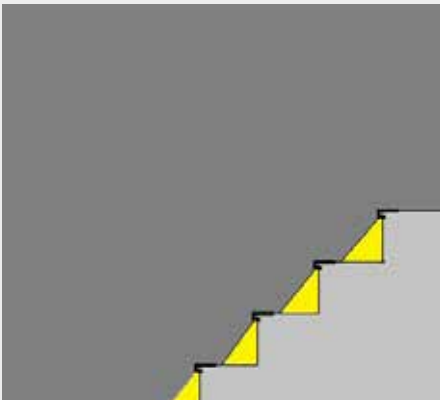

Ground Line

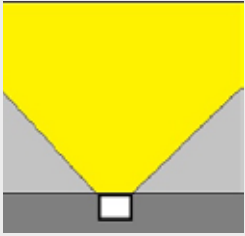

PGL-06



Aluminium Profil Ground-Line 06, alu-eloxiert BxHxL: 15,8x13,7x2000mm.

18,30 €/m

PAGL-02

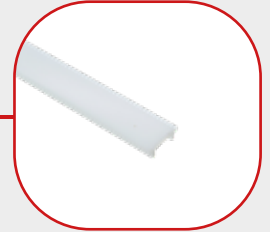

Profilabdeckung Ground-Line 02 2000mm

23,70 €/m

PEKGL-06



Endkappe für Ground-Line 06. Alu-eloxiert

2,60 €/m

PDSGL-06

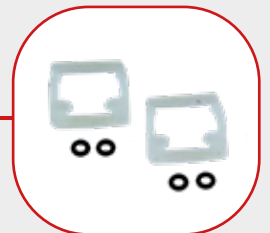

Entkappendichtungsset für PGL-06

8,30 €/Stk.

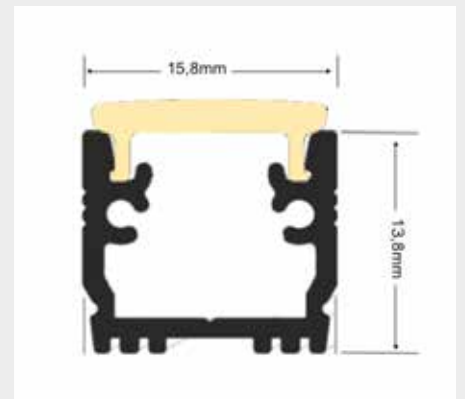

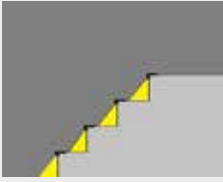

Ground Line

PGL-07s



Aluminium Profil Ground-Line 07s, alu-eloxiert BxHxL: 105,8x28,5x2000mm.

41,70 €/m

PGL-07b



Aluminium Profil Ground-Line 07b, schwarz BxHxL: 105,8x28,5x2000mm.

41,70 €/m

PAGL-03



Profilabdeckung Ground-Line 03. 2000mm

14,85 €/m

PEKGL-07s



Endkappenset für Ground-Line 07s. Alu-eloxiert

12,00 €/Stk.

PEKGL-07b

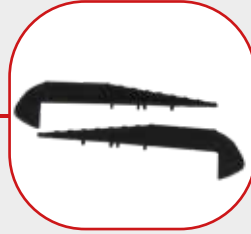

Endkappenset für Ground-Line 07b. Schwarz

12,00 €/Stk.

PAS-2003



Aluminium Profil Schiene BxHxL: 20x3x2000mm.

11,50 €/m

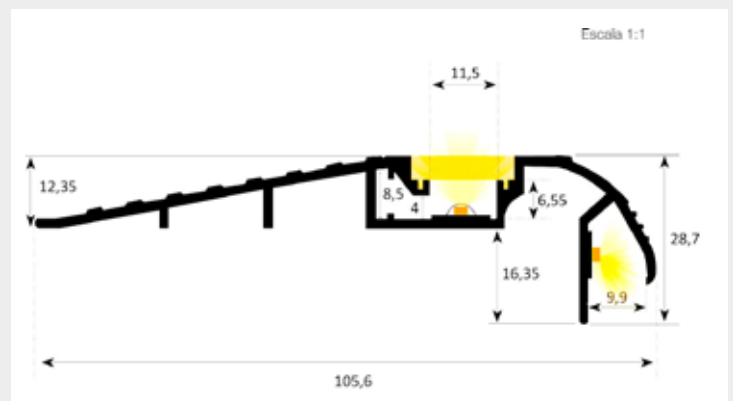

Ground Line

PAGL-08



Aluminium Profil Ground-Line 08, alu-eloxiert
BxHxL: 20,7(21,3)x11x2000mm.

23,80 €/m

PAGL-03

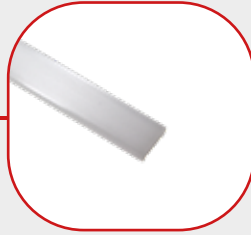

Profilabdeckung Ground-Line 03.
2000mm

14,90 €/m

PEKGL-08



Endkappe für Ground-Line 08.
Alu-eloxiert

9,70 €/Stk.

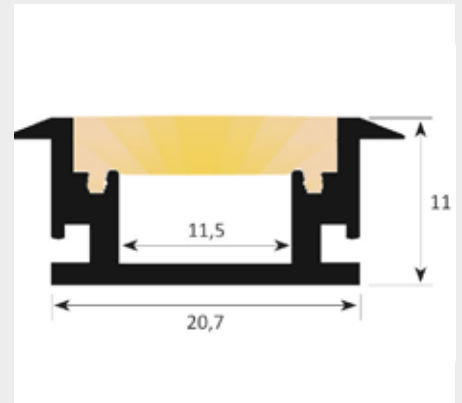
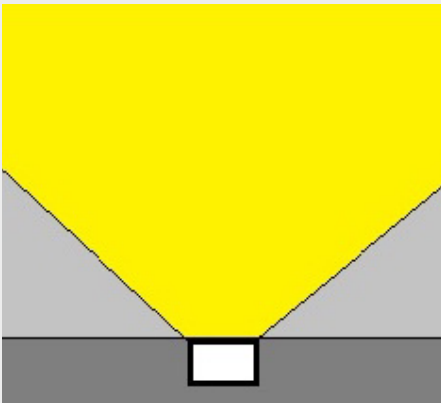

PGL-09



Aluminium Profil Ground-Line 09, schwarz-eloxiert
BxHxL: 15,8x13,7x3000mm.

47,90 €/m

PAGL-04



Profilabdeckung Ground-Line 04.
3000mm

23,60 €/m

PEKGL-09



Endkappenset für Ground-Line 09.
Alu-eloxiert

16,60 €/Set

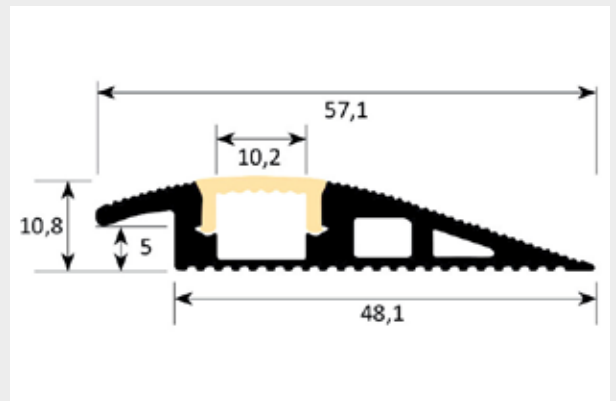
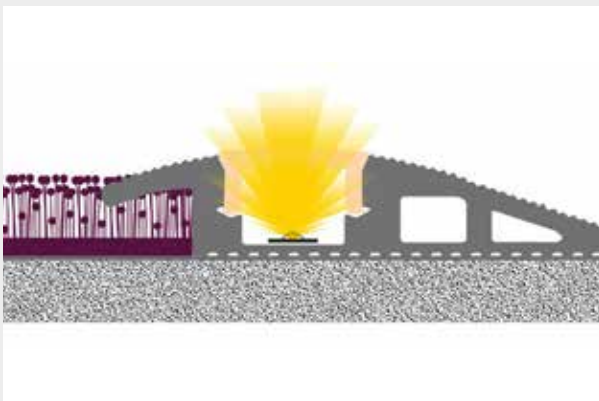

Wall and Ceiling

PWAC-01

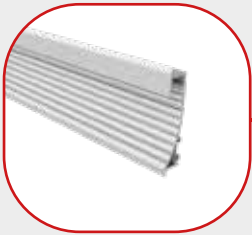

Profi-Wall and Ceiling 01
Aluminium-U-Profil
alu-eloxiert. BxHxL:
60(70)x20x2000mm
49,50 €/m

PAOP-03



Profil Abdeckung 03 für
NORDSTAR Aluminium-Profile.
Opal, 2000mm
7,60 €/m



**Andrea Stark-Nienhaus
Planerin**

PEKWAC-01

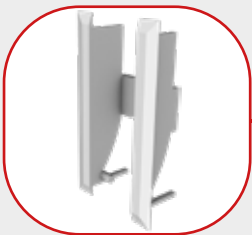

Endkappenset Wall And Ceiling
01 für Aluminiumprofil PWAC-01
26,40 €/Set.

PMF-03



Profil-Montage-Feder 03 für
Aluminiumprofile der NORDSTAR
Serie
12,70 €/Stk.

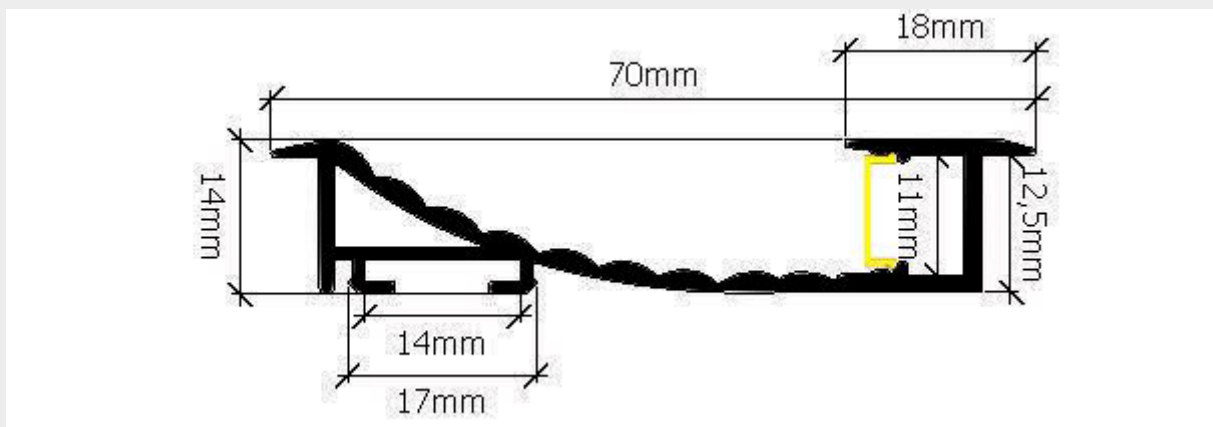
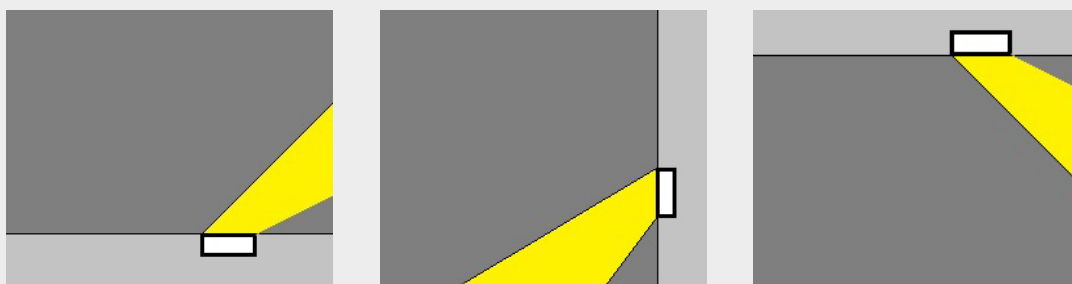

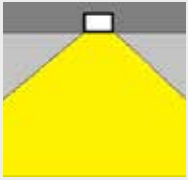

Wall and Ceiling

PWAC-02



Wall and Ceiling 02
Aluminium-U-Profil
alu-eloxiert mit Kragen.
BxHxL: 31(36)x24x2000mm

28,60 €/m

PAOP-02



Profil Abdeckung 02 für
NORDSTAR Aluminium-Profile.
Opal, 2000mm

16,50 €/m

PAOP-021

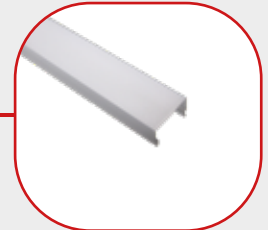

Profil Abdeckung 021 für
NORDSTAR Aluminium-Profile.
opal 2000mm

32,95 €/m

PEKWAC-02



Profil-Endkappe Wall and
Ceiling 02 für Aluminiumprofil
PWAC-02 mit Abdeckung
PAOP-02

5,40 €/Stk.

PEKWAC-021

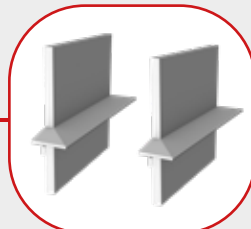

Profil-Endkappe Wall and Ceiling 021
für Aluminiumprofil PWAC-02 mit
Abdeckung PAOP-021

6,40 €/Stk.

PMK-01



Montageklammer 01 aus Federstahl
inkl Montageschraube für
NORDSTAR Aluminiumprofile

3,70€/Stk.

PMF-02

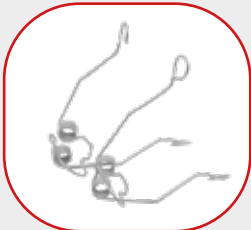

Montagefeder 02 für
NORDSTAR Aluminiumprofile
der Wall and Ceiling Line

12,70 €/Stk.

PV-00s



Profil-Verbindungselement
00 gerade schmal

5,80 €/Stk.

PV-01s



Profil-Verbindungselement 01,
90° schmal, horizontal

5,80 €/Stk.

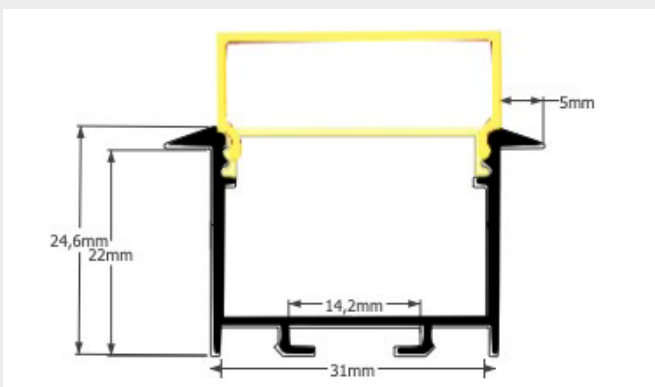

PV-02s



Profil-Verbindungselement 90°
schmal, vertikal

5,80 €/Stk.

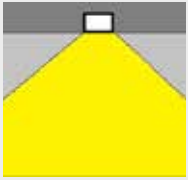

Wall and Ceiling

PWAC-03



Profi-Wall and Ceiling 03
Aluminium-U-Profil
alu-eloxiert.
BxHxL: 50(68)x23x2000mm
52,80 €/m

PAOP-07



Profil Abdeckung 07 für
Aluminiumprofile der
NORDSTAR Serien.
Opal 2000mm
31,85 €/m

PAOP-074



Profil Abdeckung 074 für
Aluminiumprofile der
NORDSTAR Serien.
Opal 2000mm
41,75 €/m

PEKWAC-03



Profil-Endkappe Wall and
Ceiling 03 für Aluminiumprofil
PWAC03 mit Abdeckung
PAOP-07
9,40 €/Stk.

PEKWAC-031

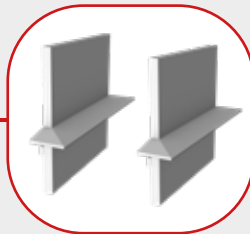

Profil-Endkappe Wall and Ceiling 031
für Aluminiumprofil PWAC03 mit
Abdeckung PAOP-071
9,90 €/Stk.

PMF-02

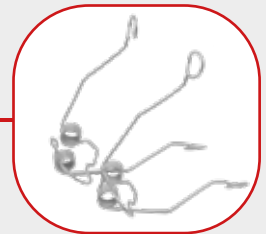

Profil-Montage-Feder 02 für
NORDSTAR Aluminiumprofile.
12,70€/Stk.

PV-00



Profil-Verbindungselement
00 gerade
5,80 €/Stk.

PV-01



Profil-Verbindungselement 01,
90° horizontal
5,80 €/Stk.

PV-02

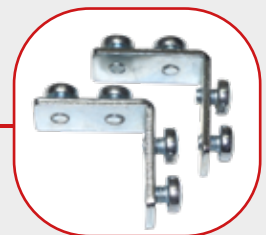

Profil-Verbindungselement
02, 90° vertikal
5,80 €/Stk.

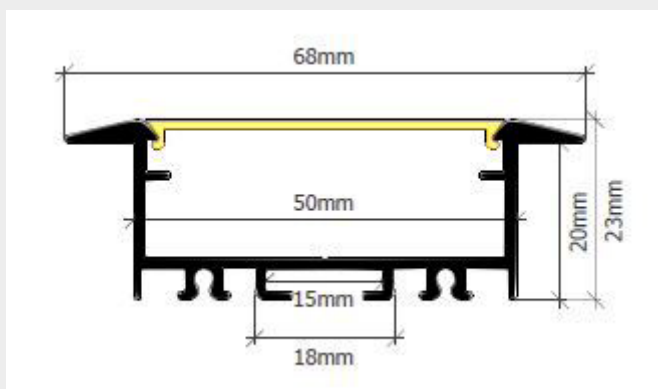

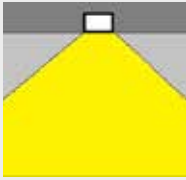

Wall and Ceiling

PWAC-04

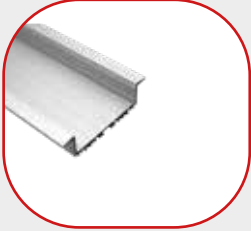

Profi-Wall and Ceiling 04
Aluminium-U-Profil alu-
eloxiert. BxHxL: 74,6(98,8)
x26,5x2000mm

74,80 €/m

PAOP-08



Profil Abdeckung 08 für
NORDSTAR Aluminiumprofile.
Opal 2000mm

46,75 €/m

PMKMF-01



Profil-Montageklammer mit
Feder 01 für NORDSTAR
Aluminiumprofile.

12,70 €/m

PMK-02



Profil-Montageklammer 02
inkl. Montageschraubefür
Aluminiumprofil der
NORDSTAR Serie.

6,50 €/Stk.

PEKWAC-04



Profil-Endkappe Wall and Ceiling 04
für Aluminiumprofil PWAC04

10,50 €/Stk.

PV-00



Profil-Verbindungselement 00
gerade

5,80 €/Stk.

PV-01



Profil-Verbindungselement 01,
90° horizontal

5,80 €/Stk.

PV-02

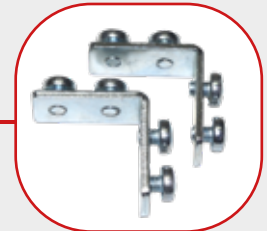

Profil-Verbindungselement
02, 90° vertikal

5,80 €/Stk.

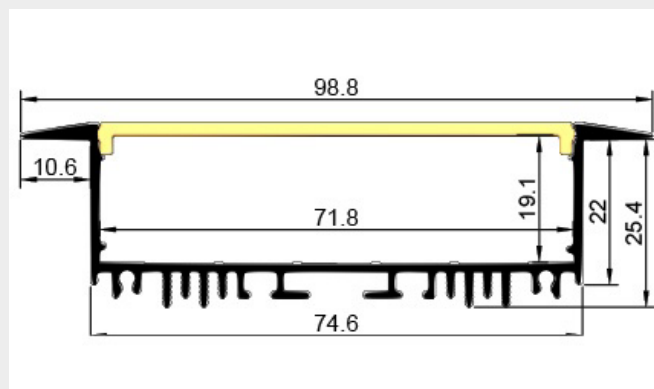

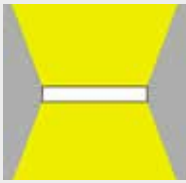

Bidirectional Line

PBL-01sA



Profi-Bidirectional Line 01A
Aluminium-Basisprofil alu-
eloxiert. Komplett
zusammengebaut. BxHxL:
85X31x2000mm
60,45 €/m

PBL-01sB

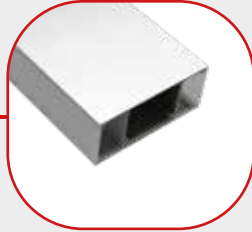

Profi-Bidirectional Line 01B
Aluminium-Abdeckprofil
alu-eloxiert. Komplett
zusammengebaut.
BxHxL: 85X31x2000mm
36,30 €/m

PBL-01wA



Profi-Bidirectional Line 01A
Aluminium-Basisprofil
creme-weisst. Komplett
zusammengebaut.
BxHxL: 85X31x2000mm
60,45 €/m

PBL-01wB



Profi-Bidirectional Line 01B Alumi-
nium-Abdeckprofil creme-weisst.
Komplett zusammengebaut.
BxHxL: 85X31x2000mm

36,30 €/m

PAOP-02



Profil Abdeckung 02 für NORDSTAR
Aluminium-Profile. Opal, 2000mm

16,50 €/m

PAOP-021



Profil Abdeckung 021 für NORDSTAR
Aluminium-Profile. Opal 2000mm

32,95 €/m

PEKBL-01s



Profil Endkappe Bidirectional
Line 01 für PBL01s mit
Abdeckung PAOP-02

8,70 €/Stk.

PEKBL-011s



Profil Endkappe Bidirectional
Line 011 für PBL01s mit
Abdeckung PAOP-021

9,35 €/Stk.

PEKBL-01w



Profil Endkappe Bidirectional
Line 01 für PBL01w mit
Abdeckung PAOP-02

8,70 €/Stk.

PEKBL-011w



Profil Endkappe Bidirectional
Line 011 für PBL01w mit
Abdeckung PAOP-021

9,35 €/Stk.

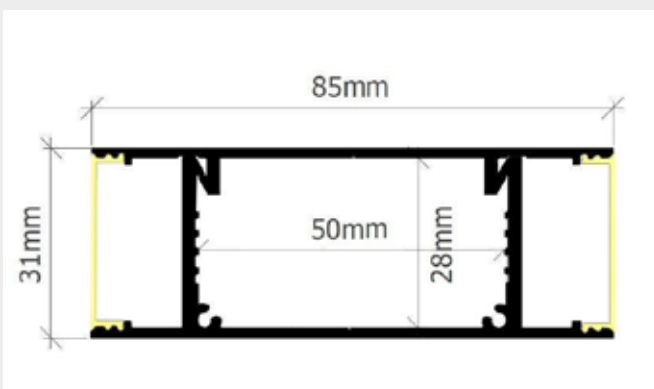



Bidirectional Line

PBL-02

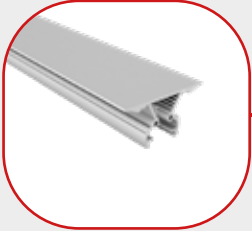

Profi-Bidirectional Line 02
Aluminium-Profil alu-eloxiert.
BxHxL: 50X24x2000mm

38,45 €/m

PAOP-01



Profil Abdeckung Star-Line 01 opal
für Aluminiumprofile der NORDSTAR
Serien. 2000mm

8,50 €/m

PAKL-01



Profil Abdeckung Star-Line 01 klar
für Aluminiumprofile der NORDSTAR
Serien. 2000mm

8,50 €/m

PMK-05

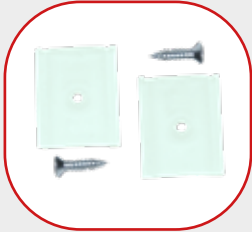

Montageklammer 05 inkl
Montageschraube für
NORDSTAR Aluminiumprofile

3,70 €/Stk.

PEKBL-02



Profil Endkappe Bidirectional
Line 02 für PBL02

6,10 €/Stk.

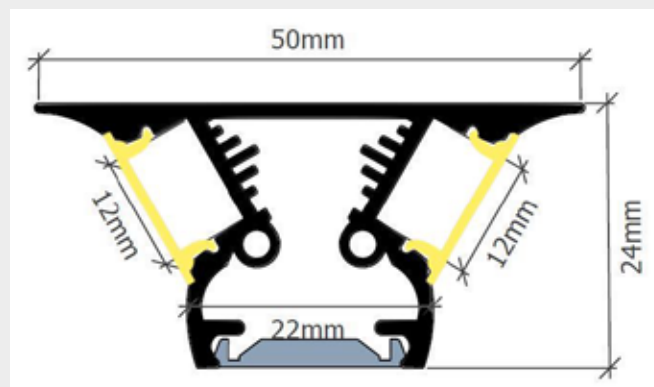



Bidirectional Line

PBL-03



Profi-Bidirectional Line 02
Aluminium-Profil alu-eloxiert.
BxHxL: 50X24x2000mm

60,45 €/m

PAOP-01



Profil Abdeckung Star-Line 01 opal
für Aluminiumprofile der NORDSTAR
Serien. 2000mm

8,50 €/m

PAKL-01



Profil Abdeckung Star-Line 01 klar
für Aluminiumprofile der NORDSTAR
Serien. 2000mm

8,50€/m

PMK-06

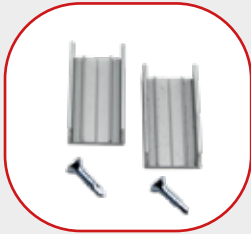

Montageklammer 06 inkl
Montageschraube für
NORDSTAR Aluminiumprofile

6,50 €/Stk.

PEKBL-03



Profil Endkappe Bidirectional
Line 02 für PBL02

6,10 €/Stk.

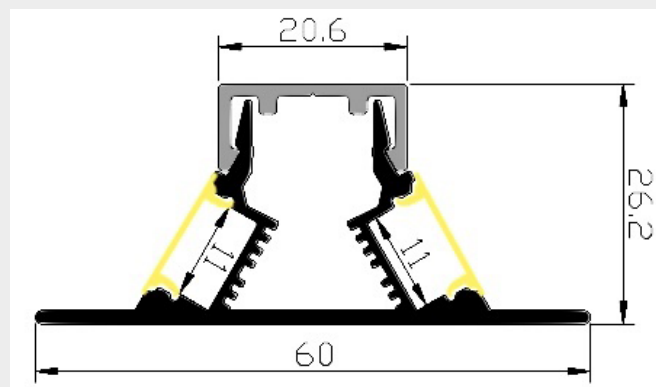



Bidirectional Line

PBL-04s



Profi-Bidirectional Line 04
Aluminium-Profil alu-eloxiert.
BxHxL: 38X29x2000mm

39,60 €/m

PBL-04w



Profi-Bidirectional Line 04 Alu-
minium-Profil weiss RAL9010.
BxHxL: 38X29x2000mm

39,60 €/m

PAOP-04

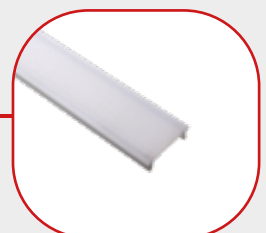

Profil Abdeckung 04 für NORDSTAR
Aluminium-Profile. Opal. 2000 mm

11,60 €/m

PAOP-03



Profil Abdeckung 03 für NORDSTAR
Aluminium-Profile. Opal 2000mm

7,60 €/m

PEKBL-04s

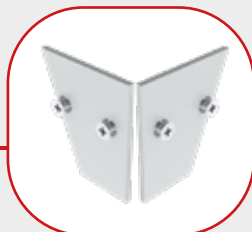

Profil Endkappe Bidirectional
Line 04s für Aluminium-Profil
PBL-04s

10,80 €/Stk.

PEKBL-04w

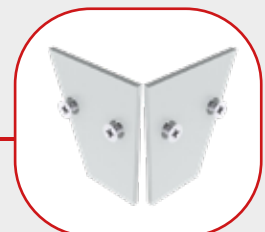

Profil Endkappe Bidirectional
Line 04w für Aluminium-Profil
PBL-04s

10,80 €/Stk.

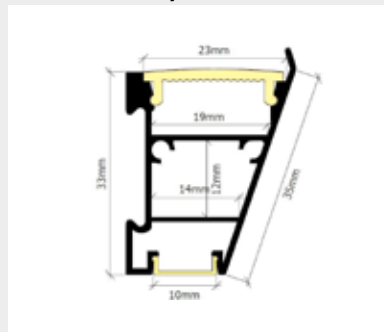

PMK-05

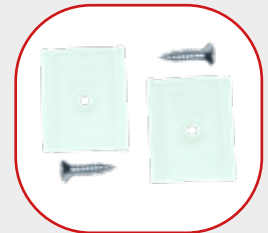

Montageklammer 05 inkl.
Montageschraube

3,70 €/Stk.





Bidirectional Line

PBL-05w

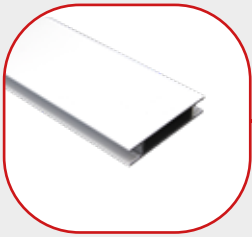

Bidirectional Line Aluminium Profil 05, weiß RAL9010, BxHxL: 91(131)x16x2000mm

Auch in alu eloxiert erhältlich

54,95 €/m

PBL-05s

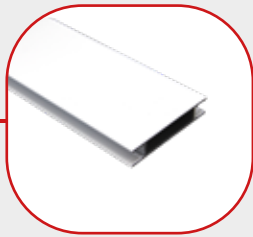

Bidirectional Line Aluminium Profil 05, alu-eloxiert, BxHxL: 91(131)x16x2000mm

54,95 €/m

PAOP-01



Profil Abdeckung 01 opal für Aluminiumprofile der NORDSTAR Serien. 2000mm

8,50 €/m

PAKL-01



Profil Abdeckung 01 klar für Aluminiumprofile der NORDSTAR Serien. 2000mm

8,50 €/m

PAOP-011

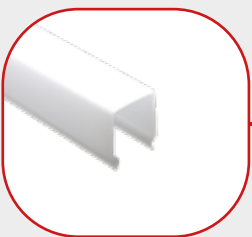

Profil Abdeckung 011 opal für Aluminiumprofile der NORDSTAR Serien. 2000mm

15,95 €/m

PAOP-012



Profil Abdeckung 012 opal für Aluminiumprofile der NORDSTAR Serien. 2000mm

20,40 €/m

PMK-05

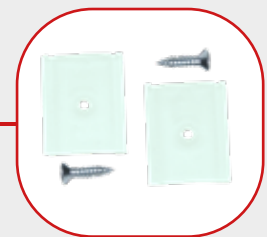

Montageklammer 05 inkl Montageschraube

3,70 €/Stk.

PEKBL-05



Profil Endkappe Bidirectional Line 05 für PBL-05 mit Abdeckung PAOP-01 oder PAKL-01

23,10 €/Stk.

PEKBL-051

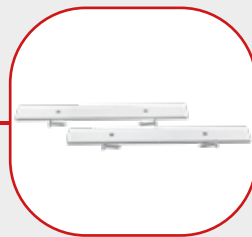

Profil Endkappe Bidirectional Line 051 für PBL-05 mit Abdeckung PAOP-011

23,10 €/Stk.

PEKBL-052



Profil Endkappe Bidirectional Line 052 für PBL-052 mit Abdeckung PAOP-012

23,10 €/Stk.

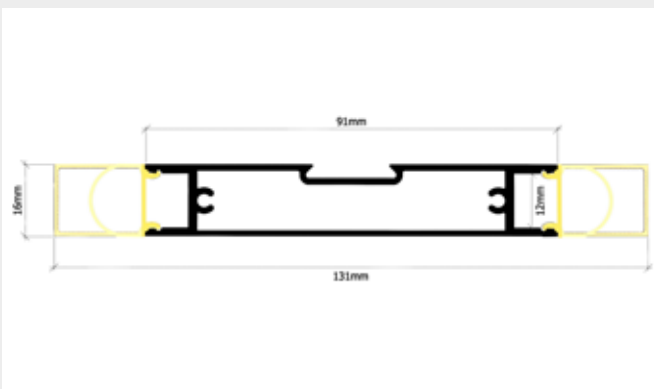

Aluminium ist heute eines der wichtigsten Materialien in der LED-Beleuchtungsindustrie. Seine Leichtigkeit, Haltbarkeit und die Möglichkeit, es in verschiedenen Formen zu verarbeiten, machen es zu einer idealen Wahl für die Herstellung von LED-Gehäusen und Kühlkörpern. Doch wie genau wird Aluminium in dieser Branche verarbeitet, und welche Rolle spielt das Eloxieren?

Die Verarbeitung von Aluminium für LED-Beleuchtungsanwendungen beginnt mit der Aluminiumlegierungsauswahl. Die richtige Legierung ist entscheidend, um die Anforderungen an Festigkeit, Haltbarkeit und Wärmeableitung zu erfüllen. Gewöhnlich werden Legierungen wie 6061 oder 6063 verwendet, die eine gute Kombination aus Festigkeit und Bearbeitbarkeit bieten..



Ein wichtiger Schritt in der Aluminiumverarbeitung für LED-Beleuchtung ist die Formgebung. Aluminium kann durch verschiedene Methoden wie Extrudieren, Gießen oder CNC-Bearbeitung in die gewünschte Form gebracht werden. Extrudieren ist besonders beliebt für die Herstellung von Gehäusen und Kühlkörpern aufgrund seiner Effizienz und Präzision.

Nachdem das Aluminium in die gewünschte Form gebracht wurde, kommt das Eloxieren ins Spiel. Das Eloxieren ist ein elektrochemischer Prozess, bei dem eine dünne, harte Schutzschicht auf der Oberfläche des Aluminiums erzeugt wird. Diese Schicht verbessert die Korrosionsbeständigkeit, Abriebfestigkeit und Ästhetik des Aluminiums erheblich.

In der LED-Beleuchtungsindustrie ist das eloxierte Aluminium von besonderer Bedeutung für die Qualität der Endprodukte. Die Schutzschicht, die durch das Eloxieren entsteht, sorgt nicht nur für eine verbesserte Haltbarkeit des Aluminiums, sondern bietet auch eine ästhetisch ansprechende Oberfläche, die sich gut in verschiedene Designkonzepte integrieren lässt.

Darüber hinaus kann das eloxierte Aluminium in verschiedenen Farben hergestellt werden, was es uns als Hersteller ermöglicht, eine Vielzahl von Optionen anzubieten und die ästhetischen Anforderungen aller Kunden zu erfüllen.

Zusammenfassend lässt sich sagen, dass die Aluminiumverarbeitung in der LED-Beleuchtungsindustrie eine entscheidende Rolle für die Qualität und Leistungsfähigkeit der Endprodukte spielt. Das Eloxieren ist dabei ein Schlüsselprozess, der dazu beiträgt, die Haltbarkeit, Ästhetik und Vielseitigkeit des Aluminiums zu verbessern..

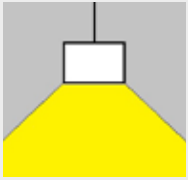

Round Line

PRL-01



Round-Line Grundprofil 01,
alu-eloxiert. Rundmaß
DxL: 17,3x2000mm

17,10 €/m

PARL-01

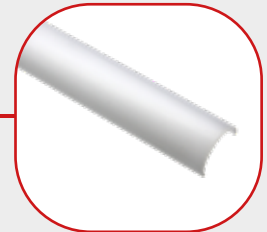

Profil Abdeckung Round-Line
01 opal. 2000mm

15,50 €/m

PRL-01RA



Rückwertige Profil Abdeckung
aus Aluminium für PRL-01,
alu-eloxier. 2000mm

8,75 €/m

PEKRL-01



Profil Endkappe Round Line 01 für
PRL-01

4,50 €/Stk.

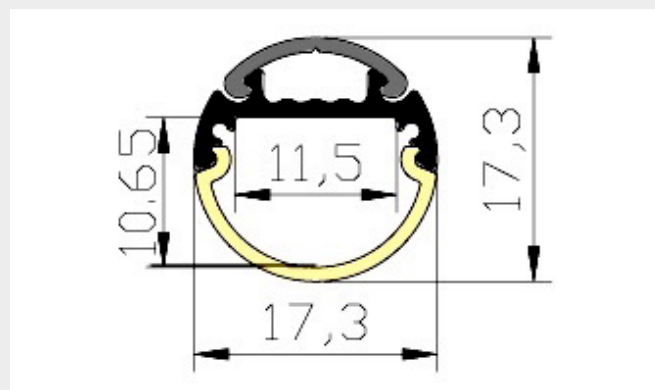

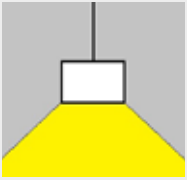

Round Line

PRL-02



Round-Line Grundprofil 02,
alu-eloxiert. Rundmaß
DxL: 30,4x2000mm

21,90 €/m

PARL-02



Profil Abdeckung Round-Line
02 opal. 2000mm

17,60 €/m

PRL-02RA



Rückwertige Profil Abdeckung
aus Aluminium für PRL-02, silber
eloxiert. 2000mm

8,75 €/m

PEKRL-02



Profil Endkappe Round Line 01 für
PRL-02

6,10 €/Stk.

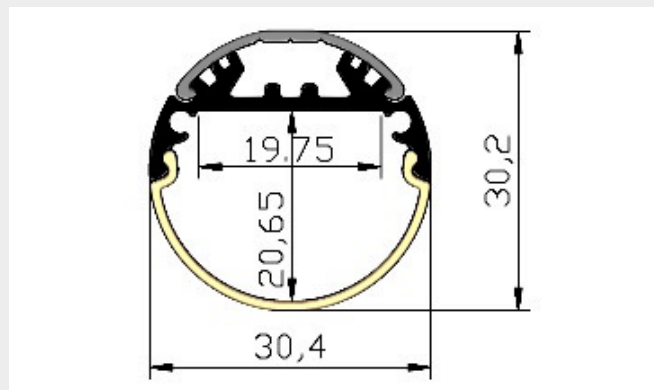

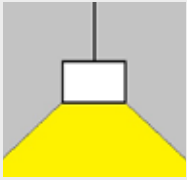

Round Line

PRL-03



Round-Line Grundprofil 03,
alu-eloxier. Rundmaß
DxL: 42,3x2000mm

37,40 €/m

PARL-03



Profil Abdeckung Round-Line
03 opal. 2000mm

31,85 €/m

PRL-03RA



Rückwertige Profil Abdeckung
aus Aluminium für PRL-03, silber
eloxiert. 2000mm

13,20 €/m

PEKRL-03



Profil Endkappe Round Line 03 für
PRL-03

8,75 €/Stk.

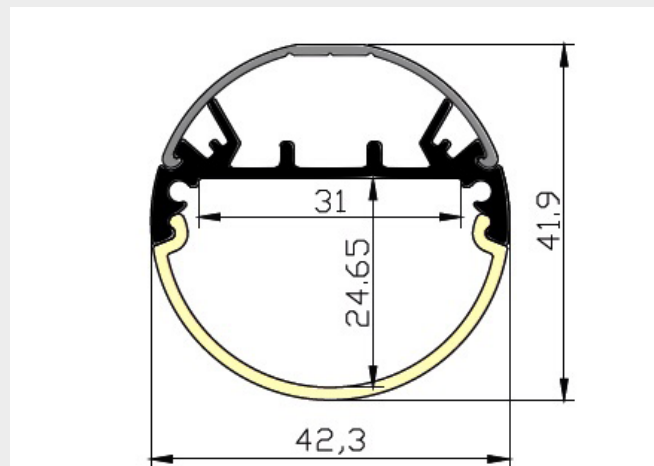

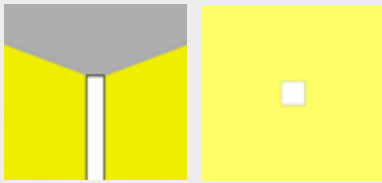

Round Line

PBL-05

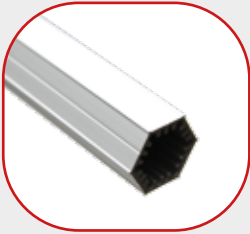

Round-Line Grundprofil 04,
alu-eloxier. 2000mm

42,80 €/m

PARL-041



Round Line Eckabdeckung 011,
opal. Maß
BxHxL: 54,3x50,2x2000mm

102,85 €/m

PARL-042



Round Line Rundabdeckung/
Röhre, 012 opal. Rundmaß
DxL: 58,4x2000mm

82,50 €/m

PEKRL-041



Profil Endkappe Round Line 04R
für PRL-04 mit Abdeckung PARL-
04

15,95 €/Stk.



PEKRL-042



Profil Endkappe Round Line 04K für
PRL-04 mit Abdeckung PARL-041

15,95 €/Stk.

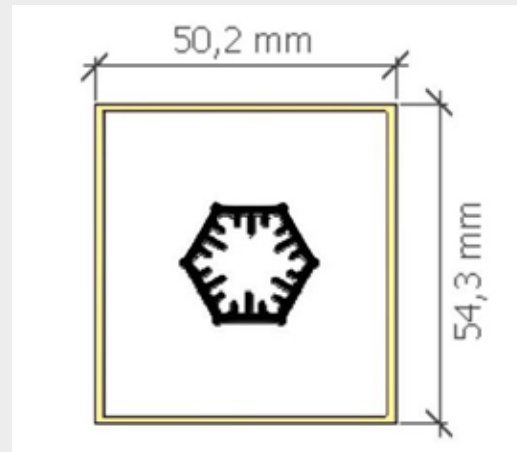
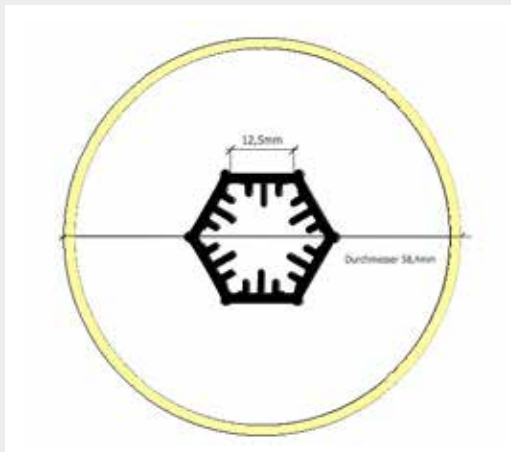

Round Line

PRL-05



Round Line 05. Opale Rundabdeckung inkl. Aluminium-Kühlprofil.
DxL: 25,6x2000mm.

49,75 €/m

PEKRL-05

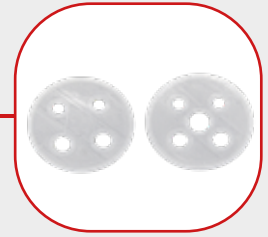

Profil Endkappe Round Line 05 für PRL-05

8,75 €/Stk.

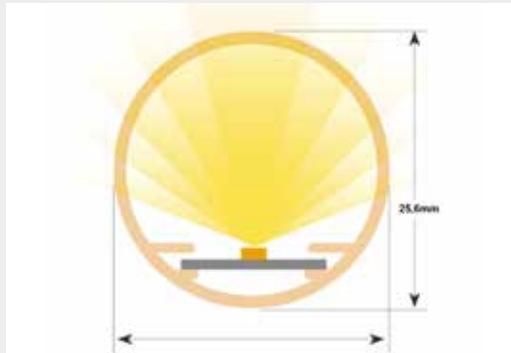

PRL-06KL



Round-Line Grundprofil 06 opal, Rundmaß 10x2000mm

43,30 €/m

PARL-06OP



Round-Line Grundprofil 06 klar, Rundmaß 10x2000mm

43,30 €/m

PEKRL-06



Profil Endkappe Round Line 06 für PRL-06

3,85 €/Stk.

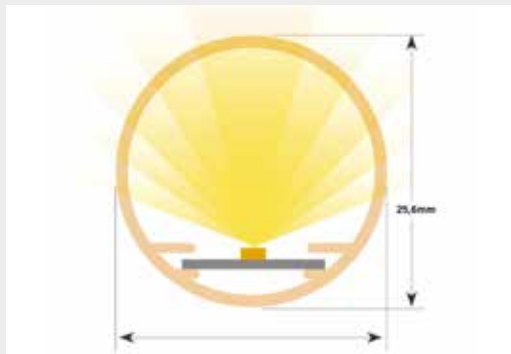

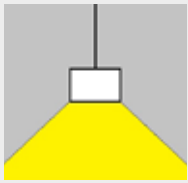

Round Line

PRL-07w

Round-Line 07w, weiß.
Rundmaß DxL: 20x2000mm

23,70 €/m

PRL-07b



Round-Line 07b, schwarz.
Rundmaß DxL: 20x2000mm

23,70 €/m

PRL-07s

Round-Line 07s, alu eloxiert.
Rundmaß DxL: 20x2000mm

23,70 €/m

PAIOP-01

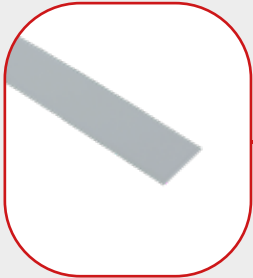

Profil Abdeckung 1OP-01
opal. 2000mm

3,20 €/m

PEKRL-07w

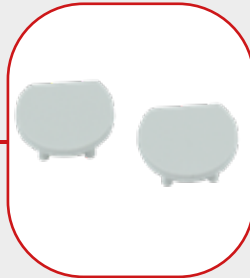

Profil Endkappe Round Line
07w (weiß) für PRL-07w

4,30 €/Stk.

PEKRL-07b



Profil Endkappe Round Line
07b (schwarz) für PRL-
07b

4,30 €/Stk.

PMKRL-02ml



Profil-Montageringklammer aus Me-
tall für Round Line Profile mit
einem \varnothing von 20mm

4,35 €/Stk.

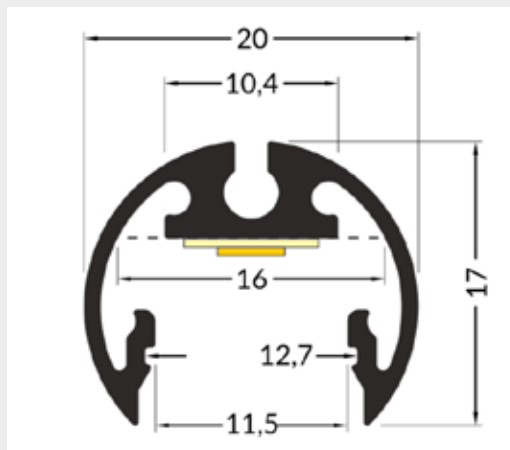

PEKRL-07s

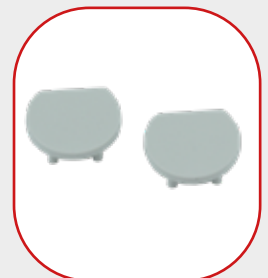

Profil Endkappe Round Line
07s (alu) für PRL-07s

4,30 €/Stk.

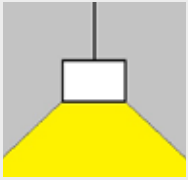

Round Line

PRL-07mini

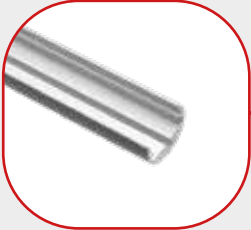

Round-Line Grundprofil 07mini,
alu-eloxiert. Rundmaß
DxL: 10x2000mm

37,40 €/m

PA10P-03



Profil Abdeckung 10P-03 opal.
2000mm

31,85 €/m

PEKRL-07mini



Profil Endkappe Round Line
07mini für PRL-07mini

4,30 €/m

PMR-01



Profil-Montageklammer aus Metall
für Round Line Profile mit
einem \varnothing von 10mm

3,70 €/Stk.

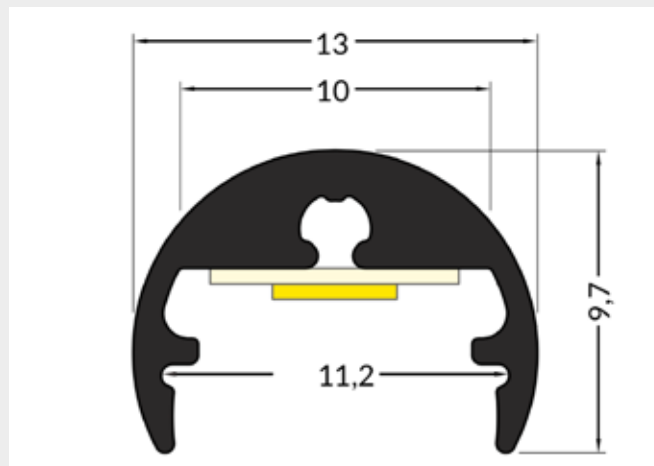



Round Line

PRL-08op



Round-Line Grundprofil 08
opal. Rundmaß
BxH: 38x3000mm

54,90 €/m

PRL-08bl



Round-Line Grundprofil 08 schwarz.
Rundmaß BxH: 38x3000mm

61,10 €/m

PAS-2301



Aluminium Profil Schiene
BxHxL: 23x1x3000mm

11,60 €/m

PEKRL-08

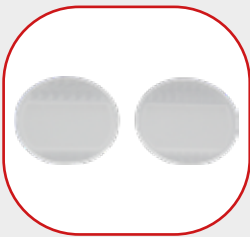

Profil Endkappe Round Line
08op (opal) für PRL-08

14,85 €/m

PEKRL-08b



Profil Endkappe Round Line 08bl
(schwarz) für PRL-08

14,85 €/m

PEKRL-08rot

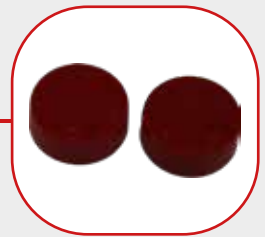

Profil Endkappe Round Line 08 (rot)
für PRL-08

14,85 €/m

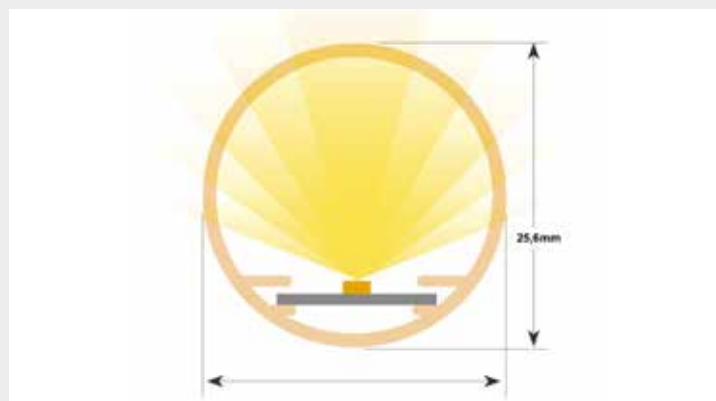

Round Line



PEKRL-08bla



Profil Endkappe Round Line 08 (blau) für PRL-08

14,85 €/Stk.

PEKRL-08wei



Profil Endkappe Round Line 08 (weiß) für PRL-08

14,85 €/Stk.

PEKRL-08sch



Profil Endkappe Round Line 08 (schwarz) für PRL-08

14,85 €/Stk.

PMK-17



Profil-Montageklammer aus Kunststoff für Round Line

20,75 €/Stk.

PMKRL-17ml



Profil-Montageklammer aus Metall für Round Line

4,55 €/Stk.

PMK-17AH



Profil-Montageklammer aus Kunststoff mit Abhängung, für Round Line

31,10 €/Stk.



Round Line

PRL-09



Round-Line 09 opal bestehend aus Grundprofil und Rundabdeckung.
BxH: 60x3000mm

65,50 €/m

PEKRL-09



Profil Endkappe Round Line 09 (weiß) für PRL-09

14,50 €/Stk.

PEKRL-09b



Profil Endkappe (dünn) Round Line 09 schwarz für PRL-09
gibt es auch in weiß (w)

14,50 €/Stk.

NLSAH-03 (set)



Seilabhängung Set 03

16,95 €/Stk.

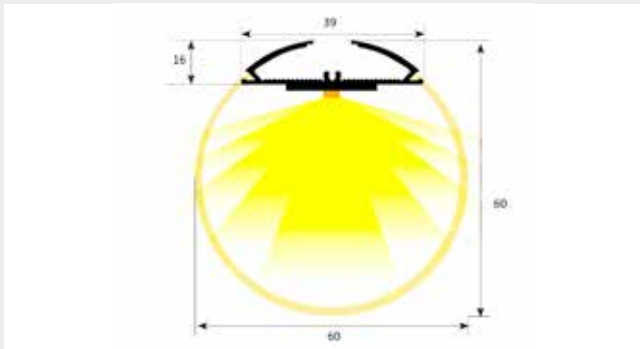

PRL-10



Round-Line 10 opal bestehend aus Grundprofil und Rundabdeckung.
BxH: 11x2000mm

27,50 €/Stk.

PARLKL-10

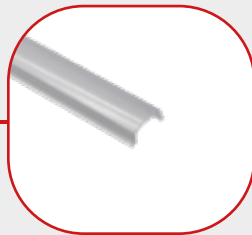

Profil Abdeckung Round Line 10 klar für PRL-10

8,75 €/Stk.

PEKRL-10



Profil Endkappe Round Line 10 für PRL-10

8,75 €/Stk.

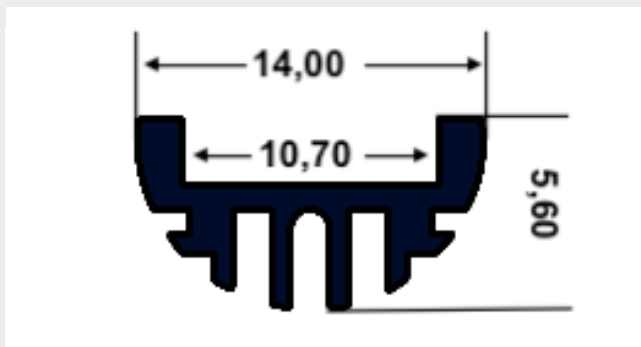

PMKRL-02ml



Montageklammer Round-Line 09

4,35 €/Stk.

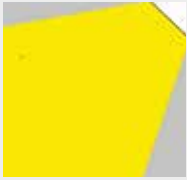

Profi Corner Line

PPCL-01



Profi Corner Line Eck-Aluminium Profil 01, alu-eloxiert. Mit Kühlrippen zur optimalen Wärmeableitung.

21,90 €/m

PAOP-01



Profil Abdeckung Start-Line 01 opal für Aluminiumprofile der NORDSTAR Serien. 2000mm

8,50 €/m

PAKL-01



Profil Abdeckung Start-Line 01 klar für Aluminiumprofile der NORDSTAR Serien. 2000mm

8,50 €/m

PEKPCL-01



Profil Endkappe Profi Corner Line 01 für PPCL-01

4,95 €/Stk.

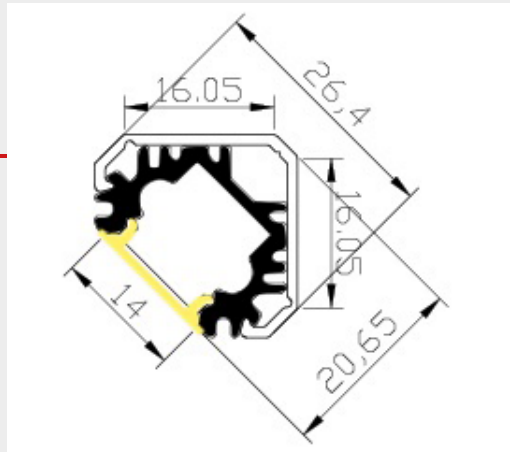

PMK-10



Profi Corner Line Montageklammer 01 inkl. Montageschraube

5,30 €/Stk.





Profi Corner Line

PPCL-02



Profi Corner Line Eck-Aluminium
Profil 02, alu-eloxiert.
BxHxL: 34,5x24,5x2000mm

15,30 €/m

PAOP-04



Profil Abdeckung 04 für
NORDSTAR Aluminium-Profile.
Opal, 2000 mm

11,60 €/m

PEKPCL-02



Profil Endkappe Profi Corner Line2
für PPCL-02

8,70 €/Stk.

PMK-11



Profil-Montageklammer Profi Corner
Line 02 inkl. Montageschraube

4,95 €/Stk.

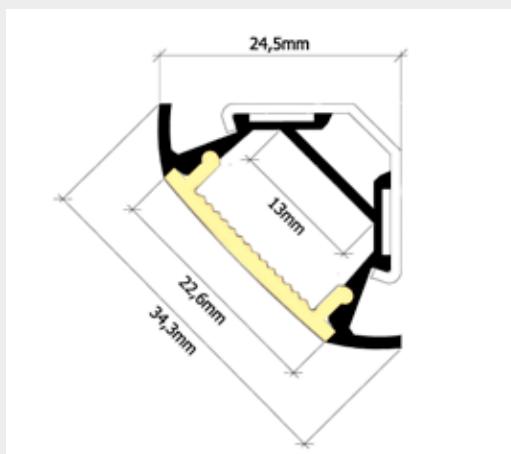



Profi Corner Line

PPCL-03



Profi Corner Line Eck-Aluminium Profil 02, alu-eloxiert.
34,5x24,5x2000mm

20,30 €/m

PAOP-12



Profil Abdeckung PAOP-12 für
NORDSTAR Aluminium-Profile.
Opal, 2000 mm

20,40 €/m

SPAOP-01p



Profil-Silikonabdeckung SPAOP-01p, ist eine opale, universale, für einige unserer Nordstar Profile einsetzbare Silikonabdeckung die gleichzeitig ultra flexibel ist und IP-Schutz bietet. Das Material ist oberflächenbehandelt, sehr robust und gleichzeitig verschafft es ein homogenes Licht mit geringer Helligkeitsabsorbierung. Lieferlänge ab 2000mm bis 30000mm

23,60 €/m

PEKPCL-03

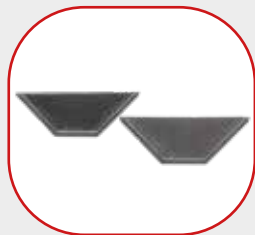

Profil Endkappe Profi Corner
Line 03 für Eck-Profil PPCL-03

8,70 €/m

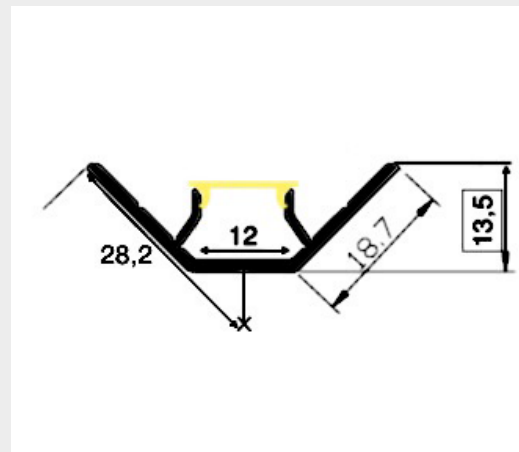



Profi Corner Line

PPCL-04



Profi Corner Line Eck-Aluminium
 Profil 02, alu-eloxiert.
 BxHxL: 34,5x24,5x2000mm

11,60 €/m

PAOPF-012

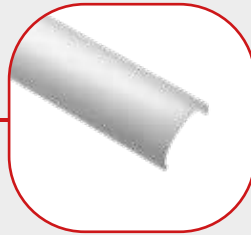

Profil Abdeckung PAOPFL-012
 für NORDSTAR Aluminium-
 Profile. Opal, 2000 mm

10,90 €/m

PEKPCL-04



Profil Abdeckung Start-Line 01
 klar für Aluminiumprofile der
 NORDSTAR Serien. 2000mm

8,70 €/m

PEKPCL-042



Profil Endkappe Profi Corner
 Line42 für PPCL-04 mit
 Abdeckung PAOPF-012

8,70 €/Stk.

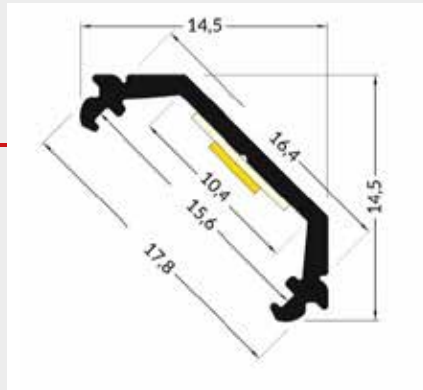

PMK-09



Profil-Montageklammer 09 inkl.
 Montageschraube

4,95 €/Stk.

PPCL-05



Profi Corner Line Eck-Aluminium
 Profil 02, alu-eloxiert.
 BxHxL: 34,5x24,5x2000mm

19,30 €/m

PAOPL-032

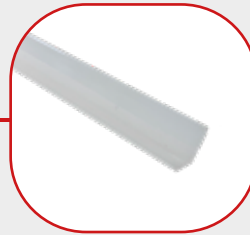

Profil Abdeckung PAOPFL-012
 für NORDSTAR Aluminium-
 Profile. Opal, 2000 mm

17,10 €/m

PEKPCL-05



Profil Abdeckung Start-Line 01
 klar für Aluminiumprofile der
 NORDSTAR Serien. 2000mm

8,70 €/m

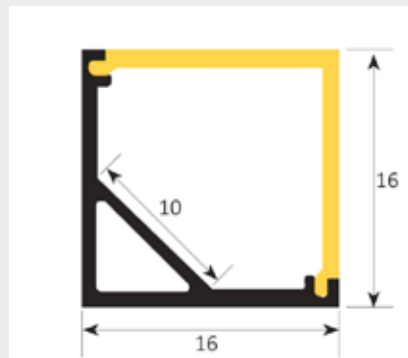

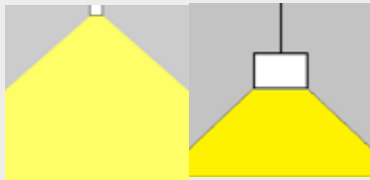

Surface Line

PSF-01



Profi Surface Line
Aluminium Profil 01, alu-eloxiert.
50X23,3x2000mm

50,10 €/m

PAOP-07



Profil Abdeckung 07 für
NORDSTAR Aluminium-Profile.
Opal, 2000 mm

31,85 €/m

PAOP-071



Profil Abdeckung 071 für
NORDSTAR Aluminium-Profile.
Opal, 2000 mm

41,75 €/m

PAOP-072



Profil Abdeckung 072 für
NORDSTAR Aluminium-Profile.
Opal, 2000 mm

41,75 €/m

PEKSF-01



Profil Endkappe Surface Line 01 für
Aluminium Profil PSF-01

13,20 €/Stk.

PEKSF-011



Profil Endkappe Surface Line 011 für
Aluminium Profil PSF-01 mit
Abdeckung PAOP-071

17,60 €/Stk.

PEKSF-012

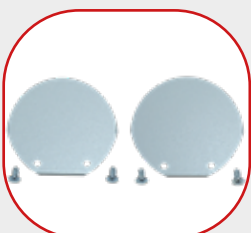

Profil Endkappe Surface Line 012
für Aluminium Profil PSF-01 mit
Abdeckung PAOP-072

17,60 €/Stk.

PMK-03



Profil Endkappe Bidirectional
Line 051 für PBL-05 mit
Abdeckung PAOP-071

7,60 €/Stk.

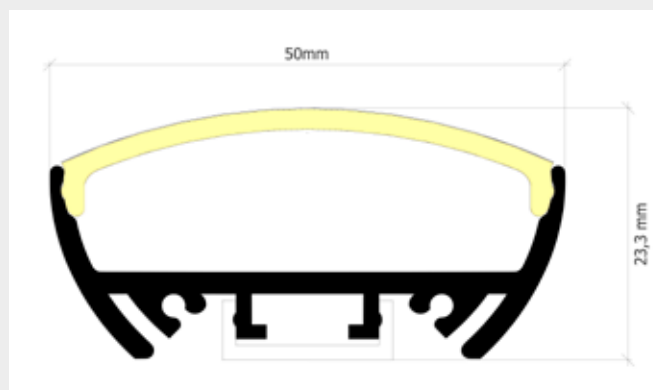

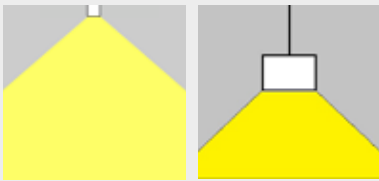

Surface Line

PSF-02



Profi Surface Line Aluminium
 Profil 01, alu-eloxiert. BxHxL: 31x23
 ,6x2000mm

26,50 €/m

PAOP-02



Profil Abdeckung 02 für
 NORDSTAR Aluminium-Profile.
 Opal. 2000 mm

16,50 €/m

PAOP-021



Profil Abdeckung 021 für
 NORDSTAR Aluminium-Profile.
 Opal. 2000 mm

32,95 €/m

PEKSF-02



Profil Endkappe Surface Line 02
 für Aluminium Profil PSF-02 mit
 Abdeckung PAOP-02

9,40 €/m

PEKSF-021



Profil Endkappe Surface Line 021 für
 Aluminium Profil PSF-02 mit Abdec-
 kung PAOP-021

9,60 €/Stk.

PMK-01



Profil-Montageklammer 01 aus Fe-
 derstahl inkl. Montageschraube

3,70 €/Stk.

PV-00s



Profil-Verbindungselement 00
 schmal gerade

5,80 €/Stk.

PV-01s



Profil-Verbindungselement 01
 schmal 90° horizontal

5,80 €/Stk.

PV-02s



Profil-Verbindungselement 02
 schmal 90° vertikal

5,80 €/Stk.

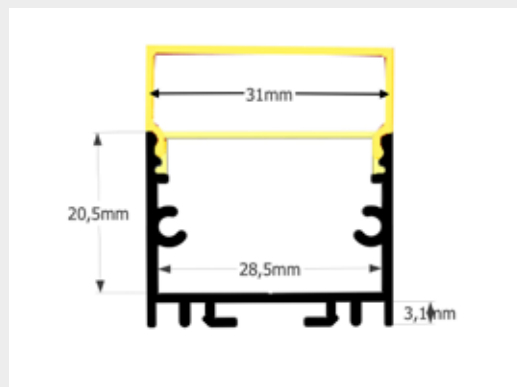

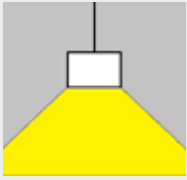

Surface Line

PSF-03

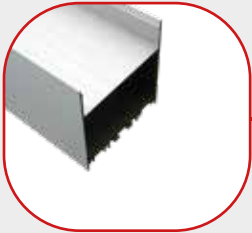

Profi Surface Line Aluminium
Profil 01, alu-eloxiert.
BxHxL: 71,8x80,3x2000mm

160,10 €/m

PAOP-08



Profil Abdeckung 08 für
NORDSTAR Aluminium-Profile.
Opal. 2000 mm

46,75 €/m

PEKSF-03



Profil Endkappe Surface Line
03 für Aluminium Profil PSF-03

9,40 €/Stk.

PMK-02



Profil-Montageklammer 02 inkl.
Montageschraube.

6,50 €/m

PV-00



Profil-Verbindungselement gerade

5,80 €/Stk.

PV-01



Profil-Verbindungselement 90°
horizontal

5,80 €/Stk.

PV-02



Profil-Verbindungselement
90° vertikal

5,80 €/Stk.

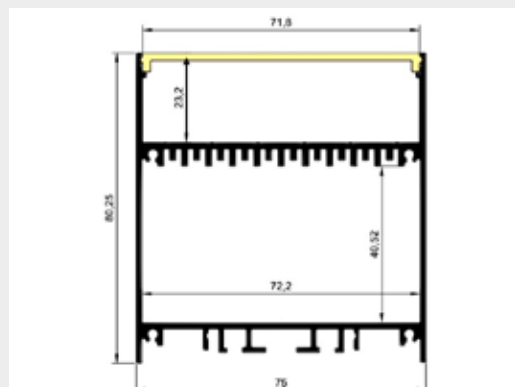

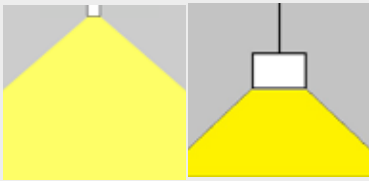

Surface Line

PSF-04

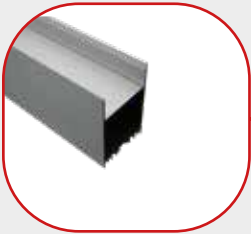

Profi Surface Line Aluminium
 Profil 04, alu-eloxiert.
 BxHxL: 50x80x2000mm

109,95 €/m

PAOP-07



Profil Abdeckung 07 für
 NORDSTAR Aluminium-Profile.
 Opal. 2000 mm

31,85 €/m

PAOP-071



Profil Abdeckung 071 für
 NORDSTAR Aluminium-Profile.
 Opal. 2000 mm

41,75 €/m

PEKSF-04



Profil Endkappe Surface Line 04
 für Aluminium Profil PSF-04

11,60 €/Stk.

PEKSF-041



Profil Endkappe Surface Line 041 für
 Aluminium Profil PSF-01 mit
 Abdeckung PAOP-071

11,60 €/Stk.

PMK-02



Profil-Montageklammer 02 inkl.
 Montageschraube

6,50 €/Stk.

PV-00



Profil-Verbindungselement
 gerade

5,80 €/Stk.

PV-01



Profil-Verbindungselement
 90° horizontal

5,80 €/Stk.

PV-02

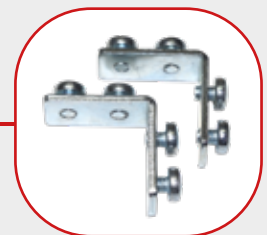

Profil-Verbindungselement
 90° vertikal

5,80 €/Stk.

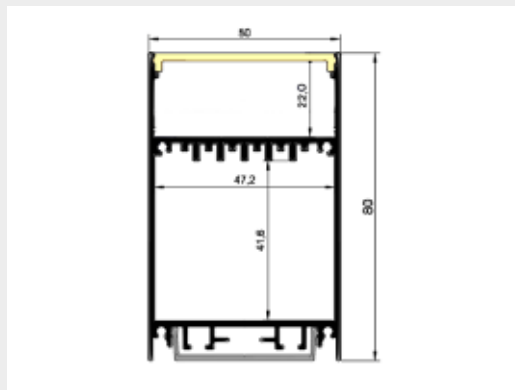



Surface Line

PSF-05



Profi Surface Line Aluminium
Profil 05, alu-eloxiert.
BxHxL: 12x12x2000mm

10,50 €/m

PA1OP-01mini

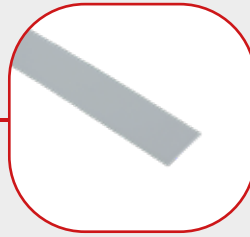

Profil Abdeckung Top-01 für
NORDSTAR Aluminium-Profile.
Opal. 2000mm

3,20 €/m

PA1OP-01



Profil Abdeckung 2op-01 für
NORDSTAR Aluminium-Profile.
Opal. 2000mm

5,80 €/m



PEKSF-05



Profil Endkappe Surface Line 05
für Aluminium Profil PSF-05

3,20 €/m

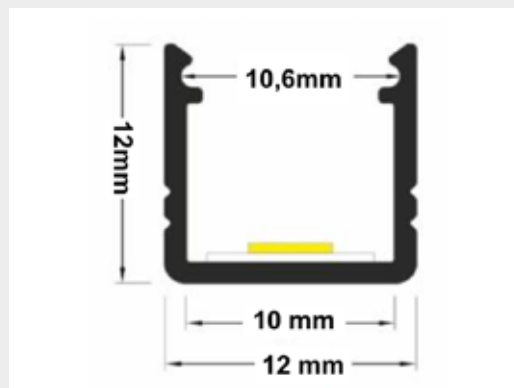

PMK-04



Profil Endkappe Surface Line 05
für Aluminium Profil PSF-05

3,60 €/m

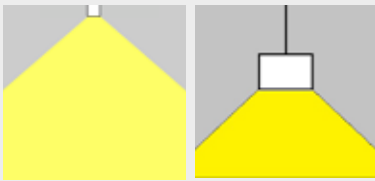

Surface Line

PSF-06



Profi Surface Line Aluminium
Profil 06, alu-eloxiert.
BxHxL: 50x30,9x2000mm

50,10 €/m

PMSSF-06

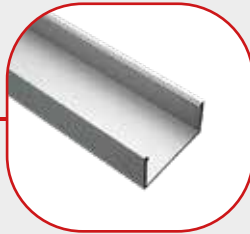

Profi Montageschiene Surface
Line für Aluminium Profil
PSP-06, alu-eloxiert.
BxHxL: 50x30,9x2000mm

50,10 €/m

PAOP-07



Profil Abdeckung 07 für
NORDSTAR Aluminium-Profile.
Opal, 2000 mm

31,85 €/m

PAOP-071



Profil Abdeckung 071 für
NORDSTAR Aluminium-Profile.
Opal, 2000 mm

41,75 €/m

PAOP-074



Profil Abdeckung 074 für
NORDSTAR Aluminium-Profile. Opal,
2000 mm

41,75 €/Stk.

PEKSF-06

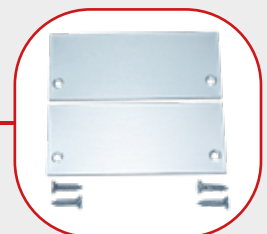

Profil Endkappe Surface Line 06 für
Aluminium Profil PSF-06 mit
Abdeckung PAOP-07

10,90 €/Stk.

PEKSF-064



Profil Endkappe Surface Line 06 für
Aluminium Profil PSF-06 mit
Abdeckung PAOP-074

13,80 €/Stk.

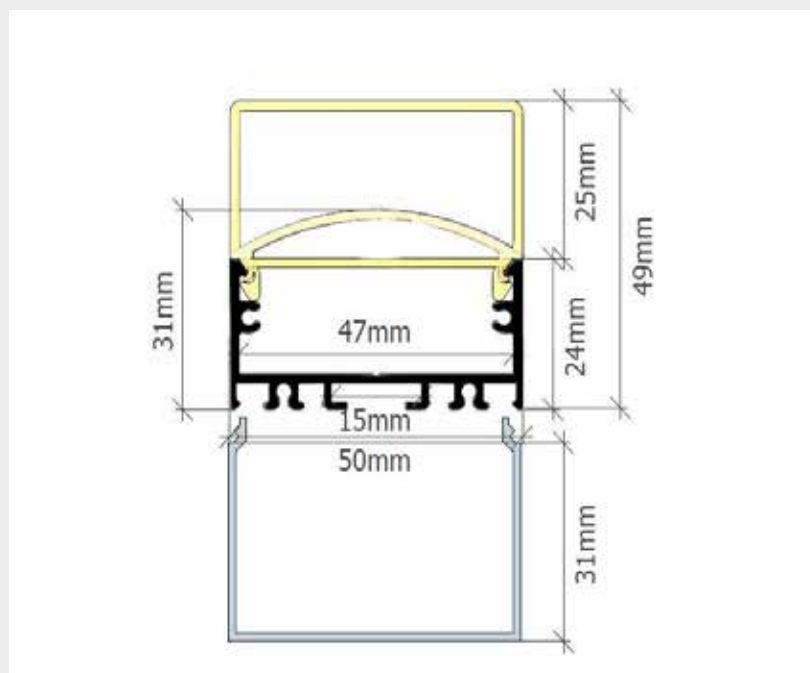

Surface Line



PEKSF-06ms



Profil Endkappe Surface Line
06ms für Aluminium Profil
PSF-06 mit Abdeckung
PAOP-07 und Montageschiene

14,20 €/Stk.

PEKSF-064ms



Profil Endkappe Surface Line
06l für Aluminium Profil PSF-06
mit Abdeckung PAOP-07l und
Montageschiene

14,80 €/Stk.

PMK-02

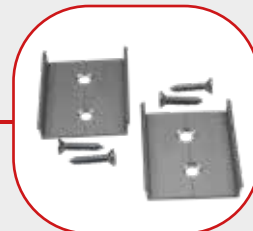

Profil-Montageklammer 02
inkl. Montageschraube

6,50 €/Stk.

PV-00



Profil-Verbindungselement
gerade

5,80 €/Stk.

PV-01



Profil-Verbindungselement 90°
horizontal

5,80 €/Stk.

PV-02

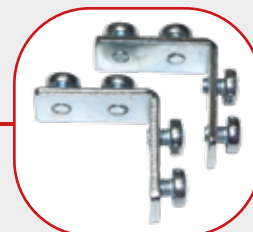

Profil-Verbindungselement 90°
vertikal

5,80 €/Stk.

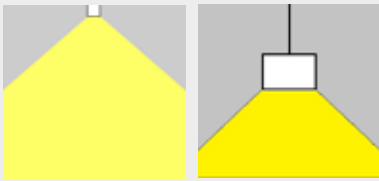

Surface Line

PSF-07

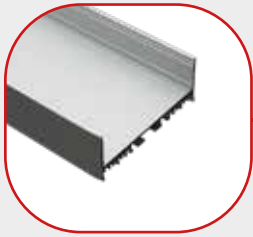

Profi Surface Line Aluminium
 Profil 07, alu-eloxiert.
 BxHxL: 74,6x30,9x2000mm

73,70 €/m

PAOP-08



Profil Abdeckung 08 für
 NORDSTAR Aluminium-Profile.
 Opal. 2000 mm

46,75 €/m

PMK-02



Montageklammer 02 inkl.
 Montageschraube für
 NORDSTAR Aluminiumprofile

6,50 €/Stk.

PEKSF-07

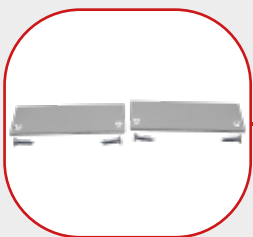

Profil Endkappe Surface Line 07
 für Aluminium Profil PSF-07

7,95 €/m

PV-00



Profil-Verbindungselement gerade

5,80 €/Stk.

PV-01



Profil-Verbindungselement 90°
 horizontal

5,80 €/Stk.

PV-02

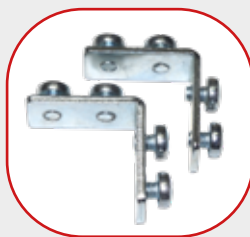

Profil-Verbindungselement
 90° vertikal

5,80 €/Stk.

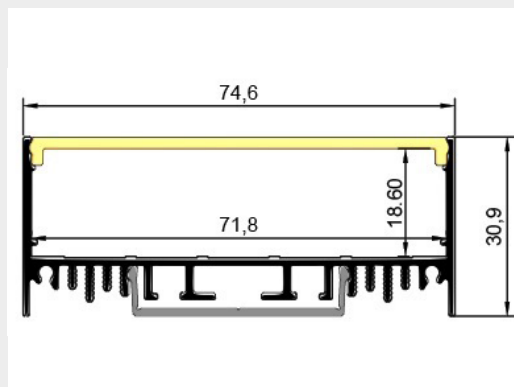

Surface Line



PSF-08



Profi Surface Line Aluminium
Profil 08, alu-eloxiert.
BxHxL: 40x8,75x2000mm

19,70 €/m

PAOP-03

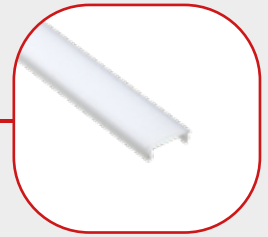

Profil Abdeckung 03 für
NORDSTAR Aluminium-Profile.
Opal 2000mm

7,60 €/m

PMK-05

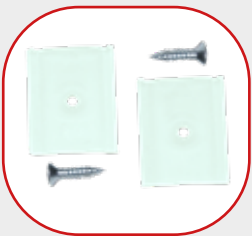

Profil-Montageklammer 05 inkl.
Montageschraube

3,70 €/Stk.



PEKSF-08



Profil Endkappe Surface Line 08 für
Aluminium Profil PSF-08

10,90 €/Stk.

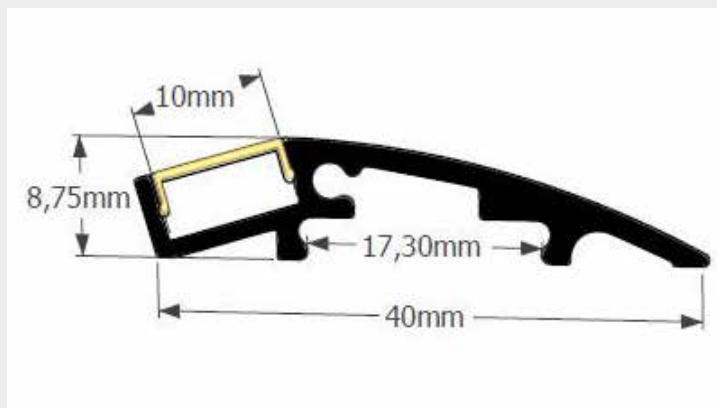

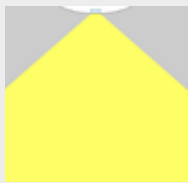

Surface Line

PSF-09



Profi Surface Line Aluminium
Profil 09, alu-eloxiert.
BxHxL: 61,7x8,7x2000mm

39,60 €/m

PAOP-01



Profil Abdeckung 01 für
NORDSTAR Aluminium-Profile.
Opal 2000mm

8,50 €/m

PAKL-01



Profil Abdeckung 01 für
NORDSTAR Aluminium-Profile.
Klar 2000mm

8,50 €/m

PMK-06



Profil-Montageklammer 06 inkl.
Montageschraube

6,50 €/Stk.

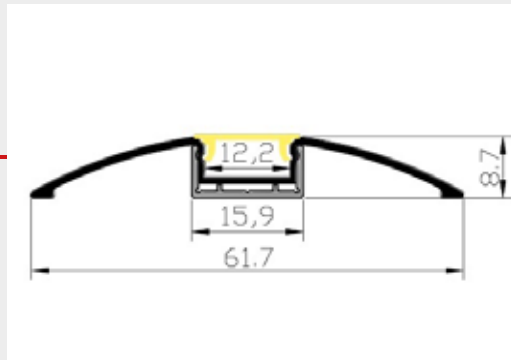

PEKSF-09



Profil Endkappe Surface Line 09 für
Aluminium Profil PSF-09

10,90 €/Stk.

PSF-10



Profi Surface Line Aluminium
Profil 10, alu-eloxiert.
BxHxL: 60x12x2000mm

39,60 €/m

PAOP-01



Profil Abdeckung 01 für
NORDSTAR Aluminium-Profile.
Opal 2000mm

8,50 €/m

PAKL-01



Profil Abdeckung 01 für
NORDSTAR Aluminium-Profile.
Klar 2000mm

8,50 €/m

PMK-06

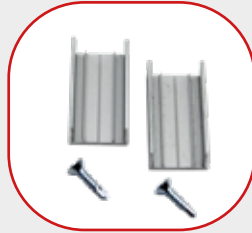

Profil-Montageklammer 06 inkl.
Montageschraube

6,50 €/Stk.

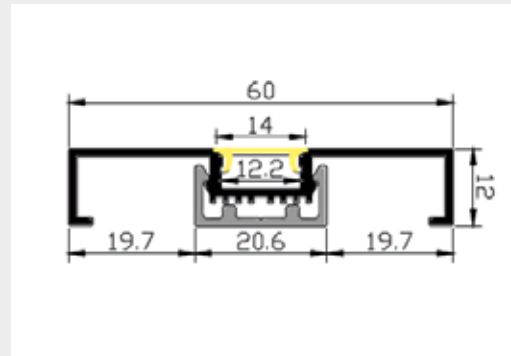

PEKSF-10

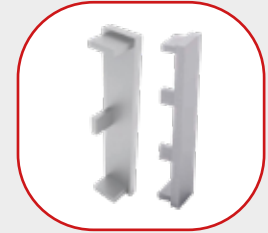

Profil Endkappe Surface Line 10 für
Aluminium Profil PSF-10

10,90 €/Stk.

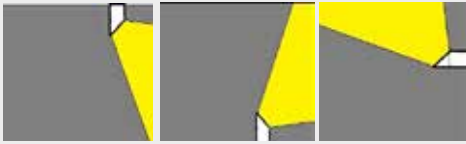

System Profi Line

PSP-01



System Profi Line Aluminium
Profil 01, alu-eloxiert. 2000mm

32,95 €/m

PSF-02



Profi Surface Line Aluminium
Profil 01, alu-eloxiert.
BxHxL: 31x23,6x2000mm

26,50 €/m

PWAC-02



Wall and Ceiling 02
Aluminium-U-Profil
alu-eloxiert mit Kragen.
BxHxL: 31(36)x24x2000mm

28,60 €/m

PAOP-02



Profil Abdeckung 02 für
NORDSTAR Aluminium-Profile.
Opal, 2000mm

16,50€/m

PAOP-021



Profil Abdeckung 021 für NORDSTAR
Aluminium-Profile.opal 2000mm

32,95 €/m

PMK-01



Profil-Montageklammer 01 aus
Federstahl inkl. Montageschraube

3,70 €/Stk.

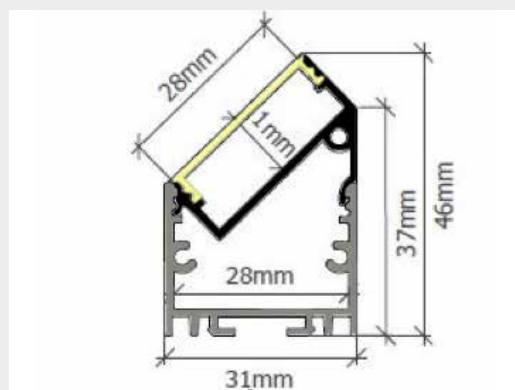

System Profi Line



PMF-02

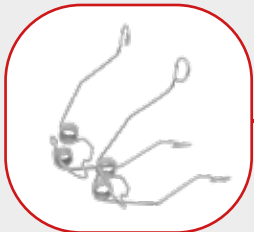

Montagefeder 02 für NORDSTAR
Aluminiumprofile

12,70 €/Stk.

PEKSP-01.1 / .2



Profil Endkappe System Profi
Line 01 für Aluminium Profil
PSP-01 mit Abdeckung
PAOP-02

17,50 €/Stk.

PEKSP-011.1 / .2



Profil Endkappe System Profi
Line 011 für Aluminium Profil
PSP-01 mit Abdeckung
PAOP-021

17,50 €/Stk.

PV-00



Profil-Verbindungselement
gerade

5,80 €/Stk.

PV-01



Profil-Verbindungselement 90°
horizontal

5,80 €/Stk.

PV-02

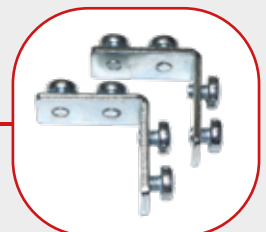

Profil-Verbindungselement 90°
vertikal

5,80 €/Stk.

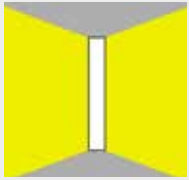

System Profi Line

PSP-02



System Profi Line Aluminium
Profil 02, alu-eloxiert.
BxHxL: 48x31x2000mm

65,95 €/m

PAOP-02



Profil Abdeckung 02 für
NORDSTAR Aluminium-Profile.
Opal. 2000 mm

16,50 €/m

PAOP-021



Profil Abdeckung 021 für
NORDSTAR Aluminium-Profile.
Opal. 2000 mm

32,95 €/m

PSP-02SF



Standfuß für System-Profi Line
PSP-02

19,75 €/Stk.

PSP-02WB



Wandbefestigung für System-Profi
Line PSP-02

14,50 €/Stk.

PSP-02SH



Schrankhalterung für System-Profi
Line PSP-02

9,10 €/Stk.

PSP-02RK



Regal-Montageklammer für
System-Profi Line PSP-02

17,10 €/Stk.

PSP-02GH



Garderobehalter für
System-Profi Line PSP-02

9,70 €/Stk.

PSP-02EV



Eck-Verbindungsglied für
System-Profi Line PSP-02

17,10 €/Stk.

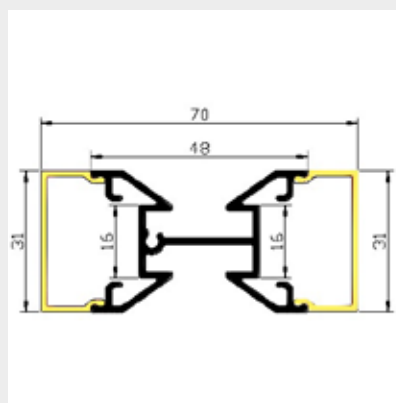

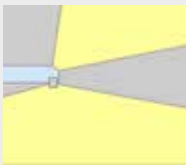

System Profi Line

PSP-03



System Profi Line Aluminium Profil 02, alu-eloxiert.
BxHxL: 16,8x11x2000mm

14,25 €/m

PAOP-05

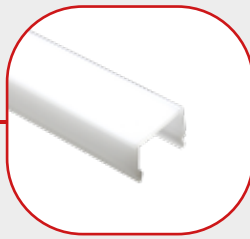

Profil Abdeckung 05 für NORDSTAR Aluminium-Profile.
Opal. 2000 mm

14,85 €/m

PEKSP-03

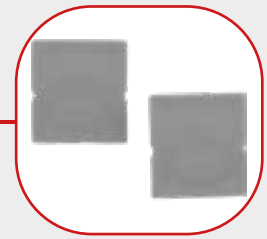

Profil Endkappe System Profi Line 03 für Aluminium Profil PSP-03

3,50 €/m

PMBSP-03



Installation-/Montagebox System Profi Line 03 für Aluminium-Profil PSP-03. Mit der Möglichkeit, ein Netzteil zu integrieren z.B das DRES24100

54,95 €/Stk.

PMK-05

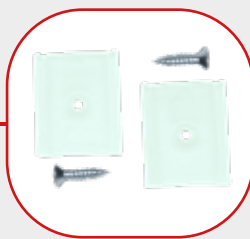

Montageklammer 05 inkl Montageschraube

3,70 €/Stk.

PMPSP-01



Profil Installationsplatte 01 für NORDSTAR Aluminium-Profile. Auch für alle Anderen Profile einsetzbar

14,25 €/Stk.

PMPSP-02



Profil Installationsplatte 02 für NORDSTAR Aluminium-Profile. Auch für alle Anderen Profile einsetzbar

14,25 €/Stk.

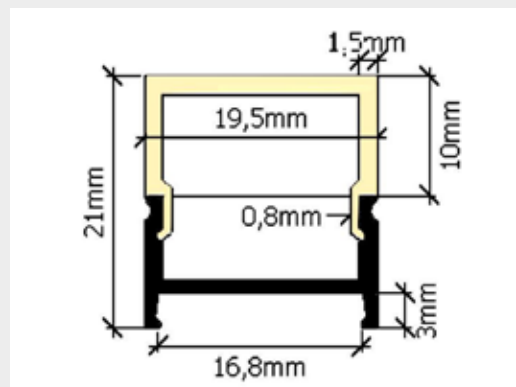
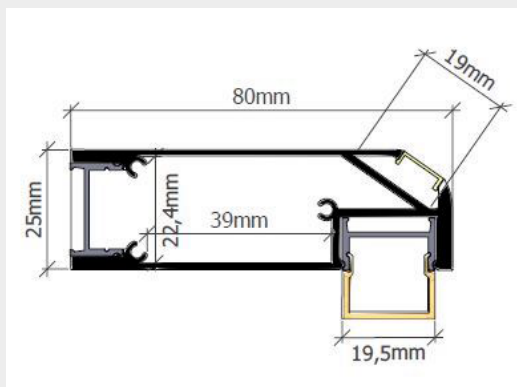

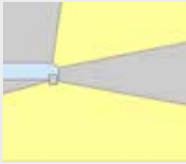

System Profi Line

PSP-04



System Profi Line Aluminium
 Profil 03, alu-eloxiert.
 BxHxL: 80x25x2000mm

143,95 €/m

PAOP-03



Profil Abdeckung 03 für
 NORDSTAR Aluminium-Profile.
 Opal 2000mm

7,60 €/m

PAOP-04

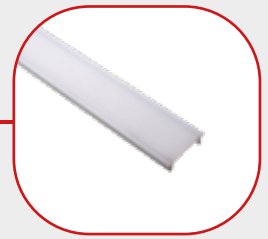

Profil Abdeckung 04 für
 NORDSTAR Aluminium-Profile.
 Opal, 2000 mm

11,60 €/m

PEKSP-04

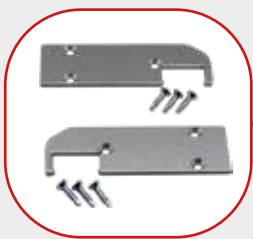

Endkappenset System Profi-Line
 04

24,75 €/Stk.

PSP-03

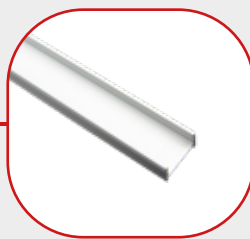

System Profi Line Aluminium Profil 03
 als Montageprofil eingesetzt oder als
 Erweiterung mit Abdeckung PAOP-05

14,25 €/Stk.

PAOP-05



Profil Abdeckung 05 für NORDSTAR
 Aluminium-Profile. Opal 2000mm

14,85 €/Stk.

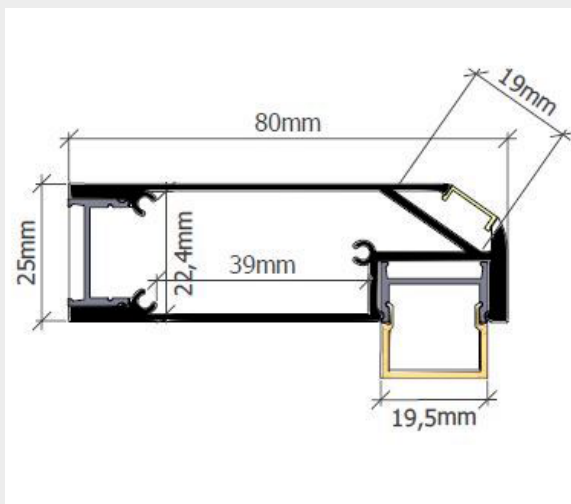

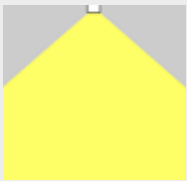

Flex Line

PFL-01s

Flex-Line 01 Aluminium-U-
Profil alu-eloxiert.
BxHxL: 20x3,3x2000mm.
Optimal für Bögen und Kreise

12,10 €/m

PFL-01b

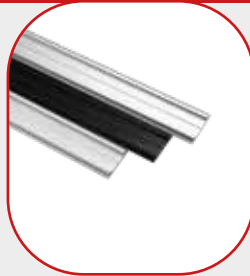

Flex-Line 01 Aluminium-U-
Profil schwarz-eloxiert.
20x3,3x2000mm. Optimal für
Bögen und Kreise

12,10 €/m

PFL-01w

Flex-Line 01 Aluminium-U-
Profil . 20x3,3x2000mm.
Optimal für Bögen und Kreise

12,10 €/m

PAOP-09



Profilabdeckung opal 09.
2000mm

7,60 €/m

PAOPF-012

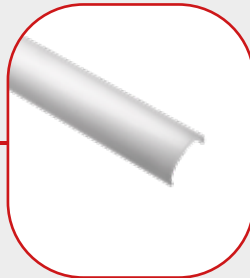

Profilabdeckung opal F-012.
2000mm

10,90 €/m

PEKFL-01s

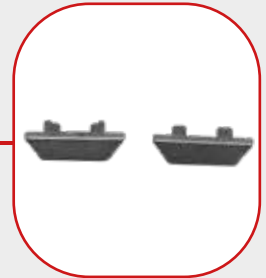

Profil-Endkappe Flex-
Line 01s silber für
Aluminium-U-Profil
PFL-01s mit Abdeckung
PAOP-09.

2,10 €/Stk.

PEKFL-012s



Profil-Endkappe Flex-Line 012s
silber für Aluminium-U-Profil
PFL-01 mit Abdeckung
PAOPF-012.

2,50 €/Stk.

PEKFL-01b

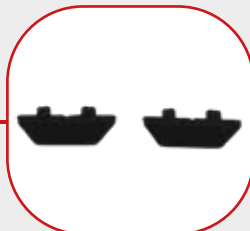

Profil-Endkappe Flex-Line 01b schwarz
für Aluminium-U-Profil PFL-01b mit
Abdeckung PAOP-09.

2,10 €/Stk.

PEKFL-012b



Profil-Endkappe Flex-Line 012s
schwarz für Aluminium-U-Profil
PFL-01b mit Abdeckung PAOPF-012.

2,50 €/Stk.

Flex Line

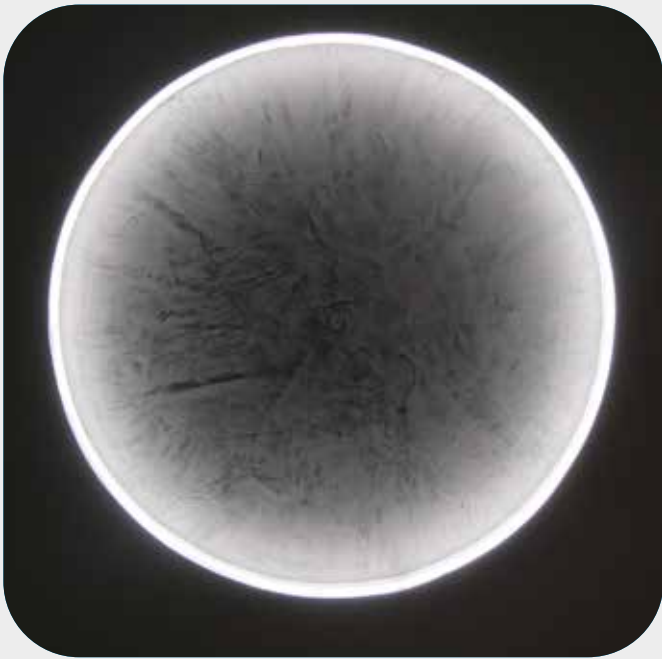

PEKFL-01w

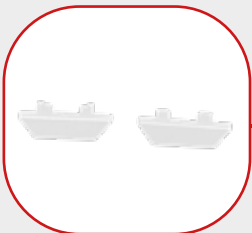

Profil-Endkappe Flex-Line 01w weiss für Aluminium-U-Profil PFL-01w mit Abdeckung PAOP-09.

2,10 €/Stk.

PEKFL-012w



Profil-Endkappe Flex-Line 012w weiss für Aluminium-U-Profil PFL-01w mit Abdeckung PAOPF-012.

2,50 €/Stk.

PMK-20



Montageklammer 20

3,70 €/Stk.

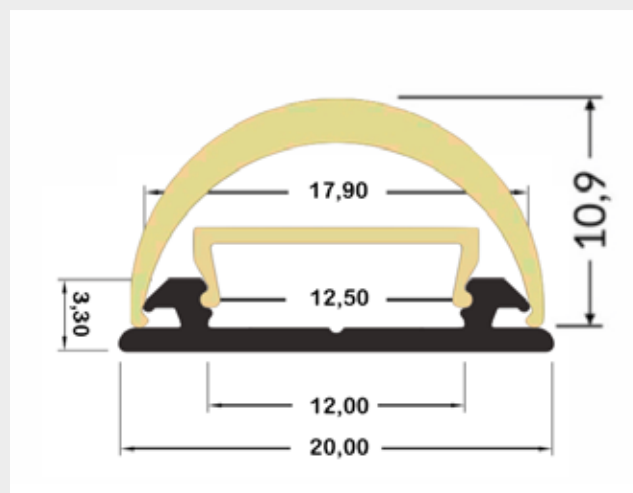

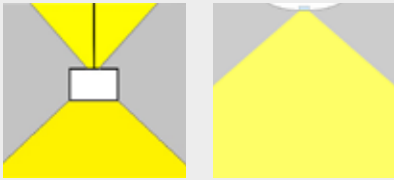

Office Line

POL-01

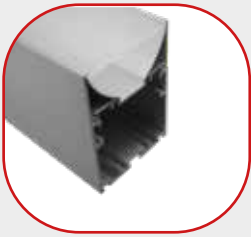

Office Line Aluminium Profil
01 alu-eloxiert.
BxHxL: 93x70x2000mm

147,35 €/m

PAUGR-01OL



Profil Abdeckung UGR-01 office
Line Blendfrei UGR-19

46,75 €/m

PAOP-01OL

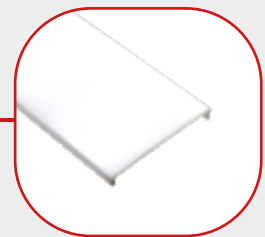

Profil Abdeckung -01OL

46,75 €/m

PAOP-01



Profil Abdeckung Star-Line 01
opal für Aluminiumprofile der
NORDSTAR Serien.
16,5x2000mm
8,50 €/Stk.

PAKL-01

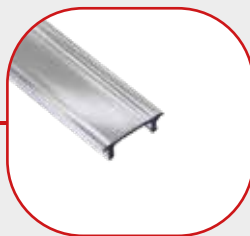

Profil Abdeckung Star-Line 01 klar für
Aluminiumprofile der NORDSTAR
Serien. 16,5x2000mm

8,50 €/Stk.

PEKOL-01



Profilendkappe OL 01 für
Aluminium-Profil office-Line -01

14,95 €/Stk.

PMK-13



Montageklammer 013

5,30 €/Stk.

PV-00s



Profil-Verbindungselement
00 gerade schmal

5,80 €/Stk.

PV-01s



Profil-Verbindungselement 01,
90° schmal, horizontal

5,80 €/Stk.

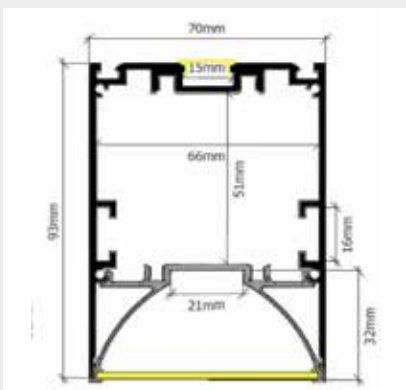

PV-02s



Profil-Verbindungselement 90°
schmal, vertikal

5,80 €/Stk.

Super Slim Line

PSSL-01



Super Slim Line Aluminium
Profil 01alu-eloxiert.
BxHxL: 8,2x12,2x2000mm

18,95 €/m

PAOPSSL-01

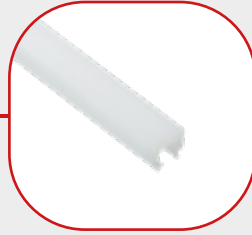

Profilabdeckung Super Slim Line 01

24,40 €/m

PEKSLL-01



Profil Endkappe Super Slim Line 01

2,50 €/Stk.

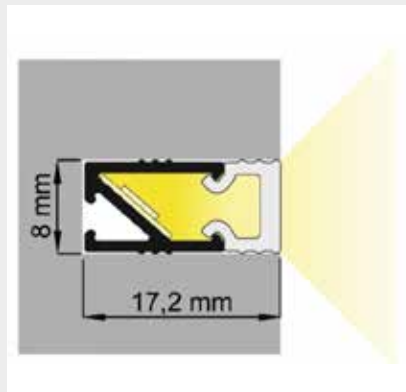
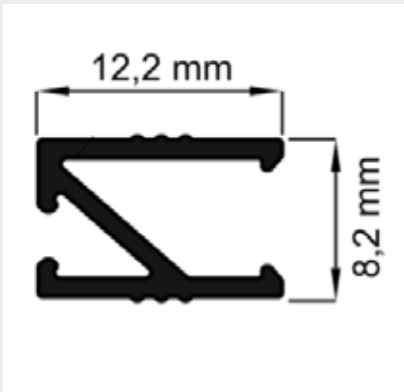

Wall Line

PWL-01

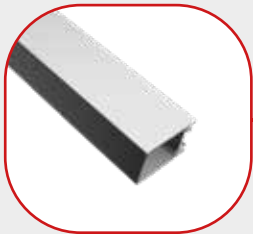

Wall Line Aluminium
Profil 01 alu-eloxiert.
BxHxL: 36,2x23,5x2000mm

37,30 €/m

PAOP-04



Profil Abdeckung 04 für NORDSTAR
Aluminium-Profile. Opal, 2000 mm

11,60 €/m

PEKWL-01

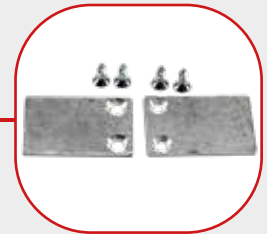

Profilendkappe Wall Line 01

20,80 €/Set

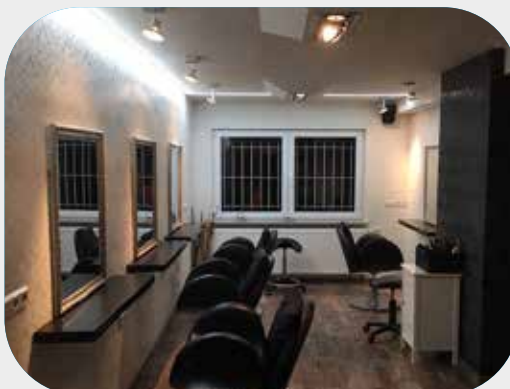
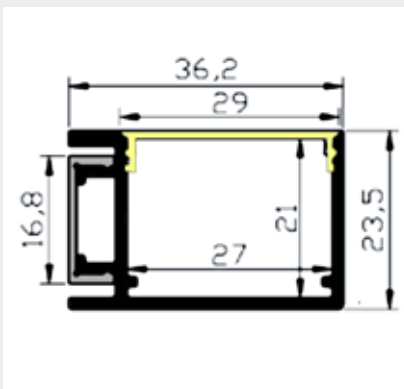

PMK-06



Profil Montageklammer 06

6,50 €/Stk.



WALL LINE

PWL-02s



Wall Line Aluminium
Profil 02 alu-eloxiert.
BxHxL:17,8x46x2000mm

63,50 €/m

PWL-02w

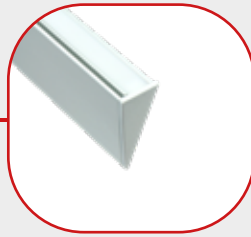

Wall Line Aluminium Profil 02
weiss. BxHxL:17,8x46x2000mm

63,50 €/m

PAOP-09

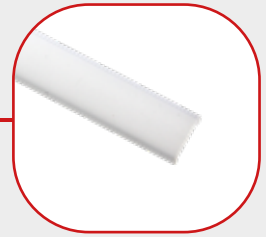

Profil Abdeckung 09. opal
2000mm

7,60 €/m

PAIL-09

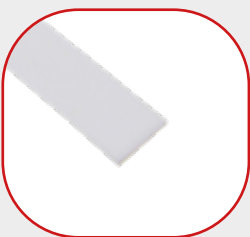

Profil Abdeckung innenliegend
09, opal 2000mm

6,20 €/m

PAOPF-012

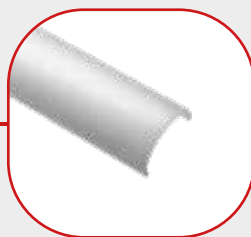

Profil Abdeckung FL-012 halbrund,
opal 2000mm

10,90 €/m

PEKWL-02s



Profilendkappenset Wall Line 02s
mit Abdeckung 09

4,95 €/Set.

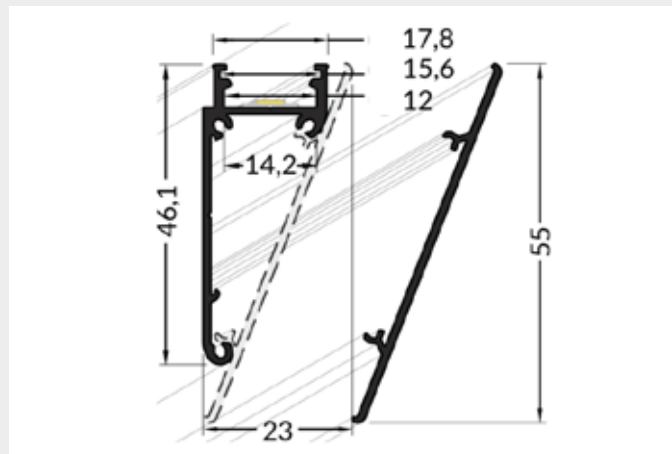



PEKWL-022s



Profilendkappenset Wall Line
022s mit Abdeckung 092

4,95 €/Set.

PEKWL-02w



Profilendkappenset Wall Line
02w mit Abdeckung 09

4,95 €/Set.

PEKWL-022w



Profilendkappenset Wall Line
022w mit Abdeckung 092

4,95 €/Set.

PIEWL-02s



Profil Innenecke alu-eloxiert
für PWL-02s

17,90 €/Stk.

PIEWL-02w



Profil Innenecke weiss für
PWL-02w

17,90 €/Stk.

PAEWL-02s



Profil Aussenecke alu-eloxiert
für PWL-02s

17,90 €/Stk.

PAEWL-02w

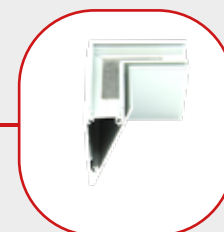

Profil Aussenecke weiss
für PWL-02w

17,90 €/Stk.

WALL LINE

PWL-03s



Wall Line Aluminium Profil 03 alu-eloxiert.
BxHxL:15,5x32x2000mm

52,60 €/m

PWL-03w



Wall Line Aluminium Profil 03 weiss.
BxHxL:15,5x32x2000mm

52,60 €/m

PWL-03b

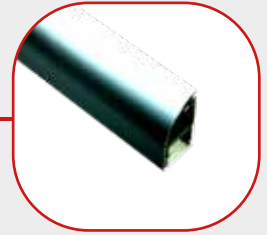

Wall Line Aluminium Profil 02 schwarz-eloxiert.
BxHxL:15,5x32x2000mm

52,60 €/m

PAOP-09

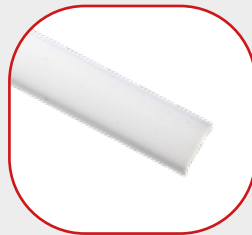

Profil Abdeckung 09. 2000mm

7,60 €/m

PEKWL-03s

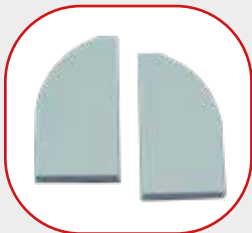

Profilendkappenset Wall Line 03s

12,80 €/Set

PEKWL-03w

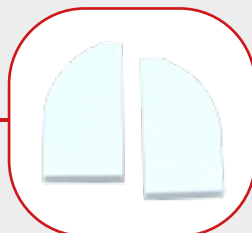

Profilendkappenset Wall Line 03w

12,80 €/Set

PEKWL-03b

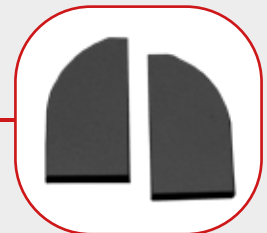

Profilendkappenset Wall Line 03b

12,80 €/Set

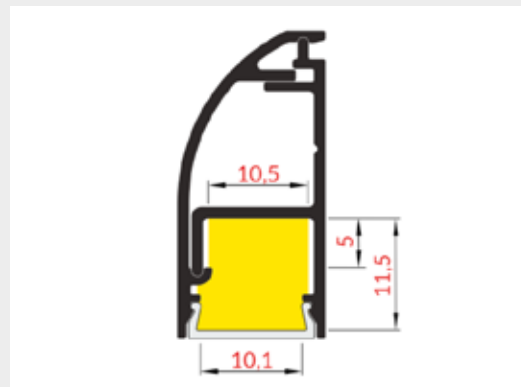

WALL LINE

PWL-04



Wall Line Aluminium Profil 04
weiss. BxHxL:15,5x32x2000mm

39,60 €/m

PAKL-02

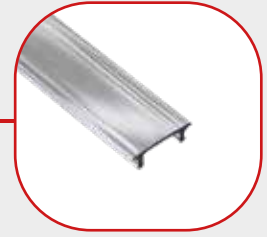

Profilabdeckung 02 klar

8,50 €/m

PEKWL-04



Profilendkappe Wall Line 04

4,10 €/m

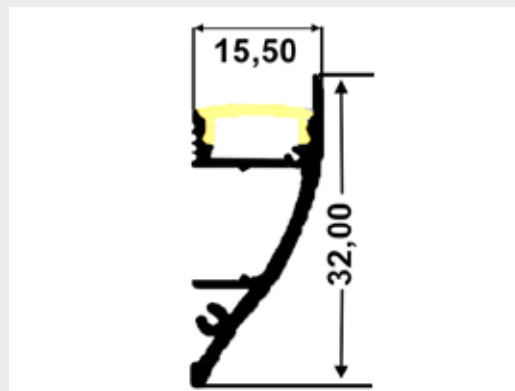

PMK-14



Montageklammer 01

3,70 €/m

PWL-05



Wall Line Aluminium Profil 05
weiß
. BxHxL:56x65x2000mm

54,45 €/m

PEKWL-05



Endkappe für
Wall Line Aluminium
Profil 05 w
BxHxL:15,5x32x2000mm
39,50 €/Set.

PVWL-05



Verbindungselement
Wall-Line 05

6,10 €/Stk.

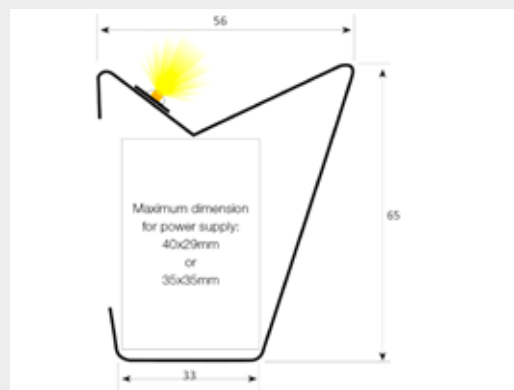

PMK-16



Montageklammer für
Wall-Line Aluminium
Profil 05

10,90 €/Stk.

Plexiglas Line

PPXG-01



Aluminium-Profil
Plexiglas-Line-01 alu-eloxiert.
BxHxL: 76x10x2000mm

20,35 €/m

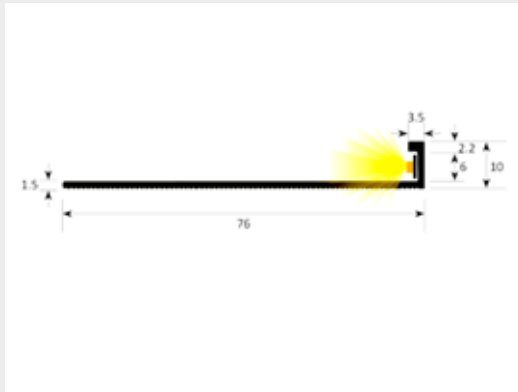

PPXG-02

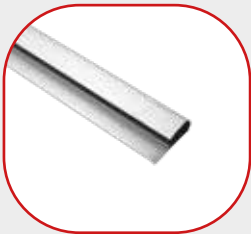

Aluminium-Profil Plexiglas-
Line-02 alu-eloxiert.
BxHxL: 40x14x3000mm

26,35 €/m

PEKPXG-02



Profilendkappenset Plexiglas
02

14,85 €/Set

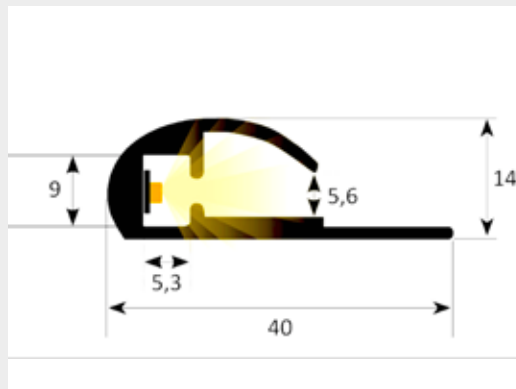

Plexiglas Line

PPXG-03



Aluminium-Profil Plexiglas-Line 03 alu-eloxiert.
BxHxL: 15x30,8x3000mm

19,70 €/m

PAOPL-01



Profil-Abdeckung L1 opal

9,20 €/m

PEKPXG-03



Profilendkappe Plexiglas -03

6,40 €/Stk.

PVL-02



Profil-Verbinder 05 (horizontal)

11,60 €/Stk.



PVL-05



Profil-Verbinder 06 (vertikal)

5,80 €/Stk.

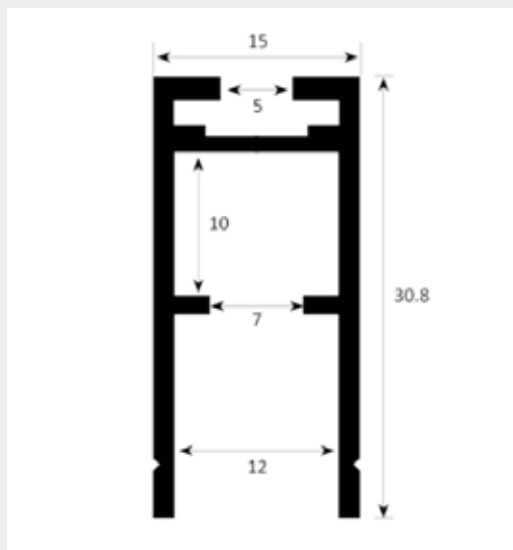

Plexiglas Line

PPXG-04



Aluminium-Profil Plexiglas 04
alu-eloxiert.
BxHxL: 50x30x3000mm

24,75 €/m

PEKPXG-04



Profilendkappe Plexiglas-04
3000mm

6,40 €/Stk.

PAS-1503

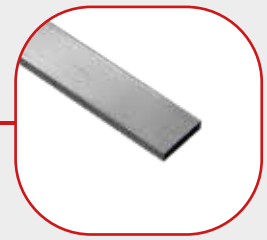

Profilschiene
BxHxL: 15x3x1000mm

6,60 €/m

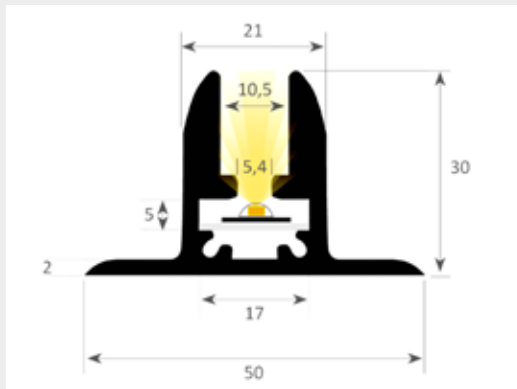

Plexiglas Line

PPXG-05



Aluminium-Grundprofil
Plexiglas Line 05 alu-eloxiert.
BxHxL: 28,9x21,5x3000mm

15,95 €/m

PVL-03Set



Profilverbinderset 04 horizontal
für Plexiglasprofil 05 (vier Stk.)

6,40 €/Set

PV-FP05

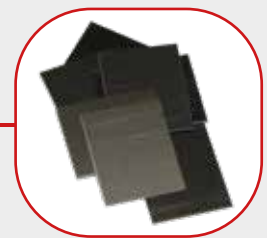

Federplättchen für Alumi-
nium-Profil Plexiglas-Line 05
(10Stk.)

4,95 €/Set

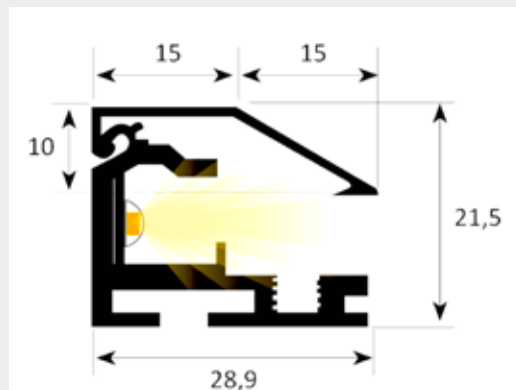

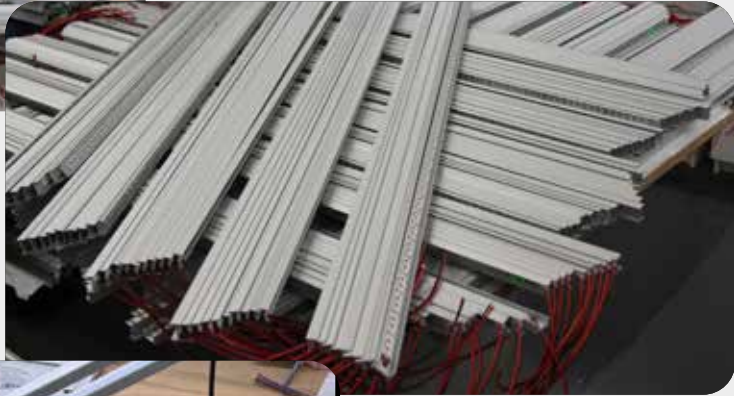

Lamp Line

PLL-01



Aluminium-Profil Lamp Line 01, alu-eloxiert.
BxHxL: 70,23x34,78x2000mm

189,95 €/m

PAOPLL-01



Profilabdeckung opal Lamp-Line 01

89,90 €/m

PEKLL-01



Endkappen Lamp-Line 01

24,90 €/Stk.

PMK-15



Montageklammer 15

15,95 €/Stk.

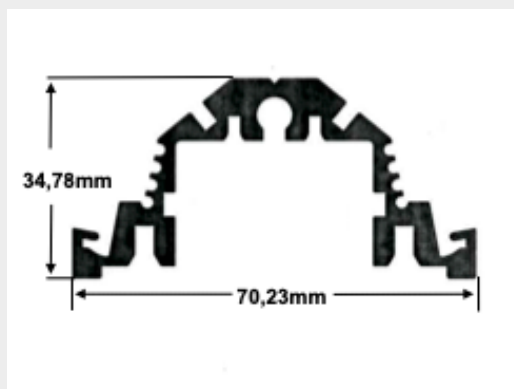

Andrea Stark-Nienhaus
Badplanerin
Vielen Dank für die Projektbilder



LED-Silikonprofile

SP-0101



Silikonprofil 0101
Halbrund opales Profil
BxHxL: 13,5x11x30000mm

17,80 €/m

SP-0201x

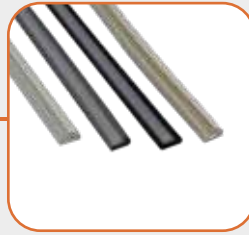

Silikonprofil 0201x
Halbrundes Profil mit
ca. 45° Lichtaustritt
BxHxL: 13,5x8x30000mm

26,50 €/m

SP-0301x

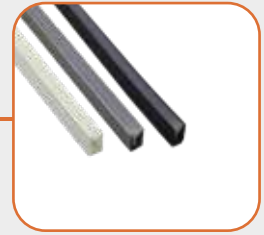

Silikonprofil 0301x
Seitlich abstrahlendes Profil
mit
BxHxL: 7x15x30000mm

28,90 €/m

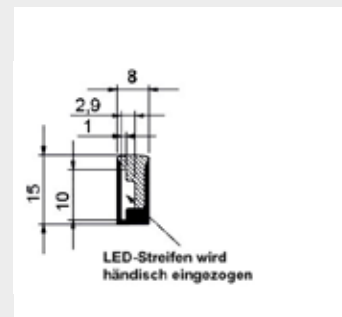
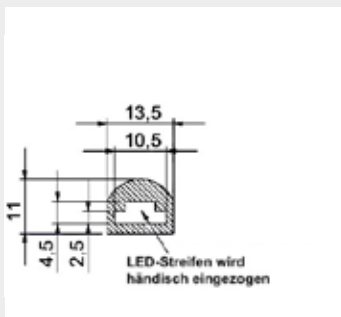

LED-Silikonprofile

SP-0401x



Silikonprofil 0401x
Halbrund opales Profil
BxHxL: 13,5x11x30000mm

30,50 €/m

SP-0501x

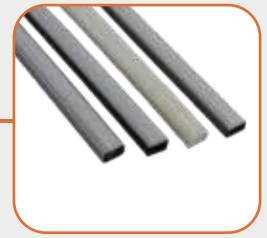

Silikonprofil 0501x
Halbrund opales Profil
BxHxL: 16,5x14x30000mm

61,50 €/m



Vorteile von LED-Streifen in Silikonformen

LED-Streifen in Silikonformen bieten zahlreiche Vorteile für vielseitige und kreative Beleuchtungslösungen. Hier sind die wichtigsten Argumente:

Flexibilität und Anpassungsfähigkeit: Dank der Silikonform sind die LED-Streifen äußerst flexibel und lassen sich leicht an verschiedene Oberflächen und Formen anpassen. Dies ermöglicht kreative Gestaltungsmöglichkeiten, sei es in Wohnräumen, Büros, Geschäften oder im Außenbereich.

Wetterfest und langlebig: Die Silikonhülle schützt die LED-Streifen vor Feuchtigkeit, Staub und anderen Umwelteinflüssen. Dadurch sind sie ideal für den Einsatz im Freien oder in feuchten Innenbereichen wie Badezimmern und Küchen geeignet. Die hohe Lebensdauer der LEDs sorgt zudem für eine langfristige Beleuchtungslösung.

Vielseitige Beleuchtungsoptionen: Verschiedene LED-Typen können in die Silikonformen eingezogen werden, sodass Sie die Lichtfarbe und -intensität individuell an Ihre Bedürfnisse anpassen können. Ob warmweißes Licht für eine gemütliche Atmosphäre oder farbige LEDs für besondere Akzente – die Möglichkeiten sind nahezu unbegrenzt.

Einfache Installation: Die LED-Streifen sind bis zu 12 Meter lang und lassen sich problemlos zuschneiden und verbinden, um die perfekte Länge für Ihr Projekt zu erzielen. Die flexible Form erleichtert die Montage auch an schwierigen Stellen und ermöglicht eine nahtlose Integration in Ihr Beleuchtungskonzept.

Energieeffizienz: LEDs sind bekannt für ihre hohe Energieeffizienz und niedrigen Betriebskosten. Sie verbrauchen weniger Strom als herkömmliche Leuchtmittel und tragen so zur Reduzierung der Energiekosten und des CO₂-Fußabdrucks bei.

LED-Streifen in Silikonformen bieten eine moderne, praktische und ästhetisch ansprechende Beleuchtungslösung für vielfältige Anwendungen.

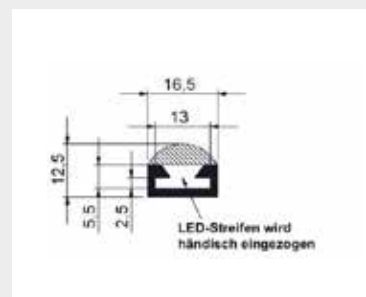
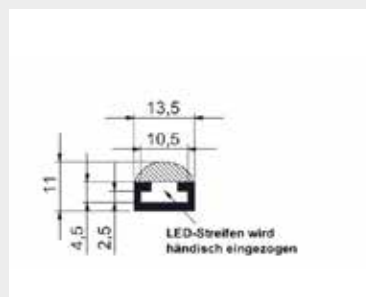

Stuckleisten für LED-Beleuchtung

SL-0101

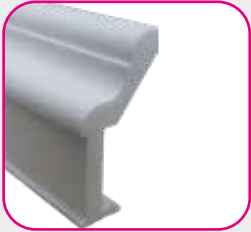

Stuckleiste 0101
BxHxL: 186x90x2000mm

38,00 €/m

SL-0102



Stuckleiste 0102
BxHxL: 185x90x2000mm

39,50 €/m

SL-0103



Stuckleiste 0103
BxHxL: 90x90x2000mm

29,00 €/m

SL-0104



Stuckleiste 0104
BxHxL: 186x100x2000mm

45,90 €/m

SL-0105

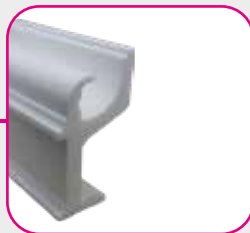

Stuckleiste 0105
BxHxL: 184,5x102x2000mm

45,90 €/m

SL-0106

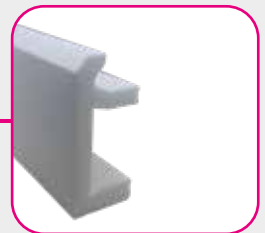

Stuckleiste 0106
BxHxL: 190x82x2000mm

44,50 €/m

SL-0107



Stuckleiste 0107
BxHxL: 135x66,5x2000mm

34,90 €/m



SL-0108



Stuckleiste 0108
BxHxL: 136x60x2000mm

34,50 €/m



Stuckleisten für LED-Beleuchtung

SL-0109

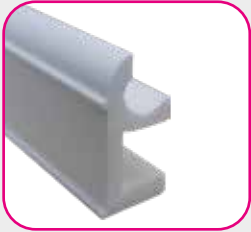

Stuckleiste 0109
BxHxL: 135x67x2000mm

37,90 €/m

SL-0110



Stuckleiste 0110
BxHxL: 137x70x2000mm

39,90 €/m

SL-0111



Stuckleiste 0111
BxHxL: 100x100x2000mm

38,00 €/m

SL-0112



Stuckleiste 0112
BxHxL: 90,5x97x2000mm

38,00 €/m

SL-0113



Stuckleiste 0113
BxHxL: 137x70x2000mm

39,90 €/m

SL-0114



Stuckleiste 0114
BxHxL: 85x70x2000mm

29,00 €/m

SL-0115



Stuckleiste 0115
BxHxL: 61x88,5x2000mm

29,90 €/m

SL-0116



Stuckleiste 0116
BxHxL: 100x100x2000mm

42,80 €/m

SL-0117



Stuckleiste 0117
BxHxL: 76x115x2000mm

39,90 €/m

SL-0118



Stuckleiste 0118
BxHxL: 56,5x56,5x2000mm

38,00 €/m

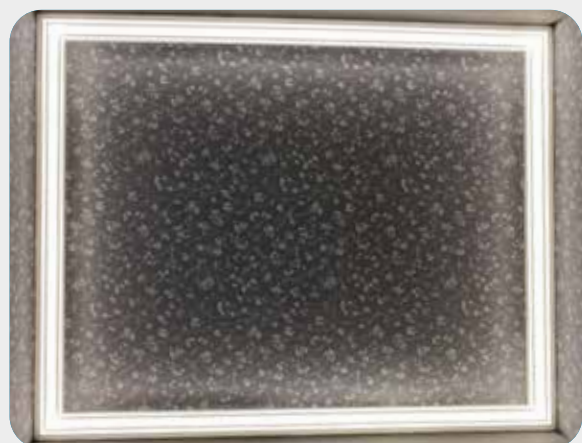

Stuckprofile für LED-Beleuchtung

12DC



DR12006

Festspannungsnetzteil
12VDC, 6Watt,
0,5A, IP20.

12,95 €

DR12015



Festspannungsnetzteil
12VDC, 15Watt,
1,25A, IP20, MM, CE
BxHxL: 40x16x130mm

27,95 €

DR12030



Festspannungsnetzteil
12VDC, 30Watt,
2,5A, IP20, MM, F
BxHxL: 45x28x140mm

33,50 €

DR12060



Festspannungsnetzteil
12VDC, 60Watt,
5A, IP20, MM, F
BxHxL: 54x36x157mm

57,95 €

DR12100



Festspannungsnetzteil
12VDC, 100Watt,
8,4A, IP20, MM, F
BxHxL: 60x35x230mm

91,95 €

DR12150



Festspannungsnetzteil
12VDC, 150Watt,
12,5A, IP67, MM, F
BxHxL: 60x36,5x192mm

115,95 €

24DC

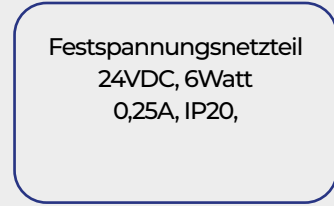

DR24006

Festspannungsnetzteil
24VDC, 6Watt
0,25A, IP20,

12,95 €

DR24015

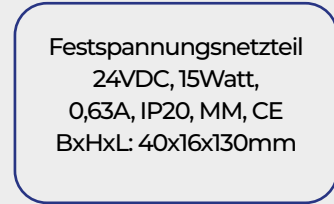

Festspannungsnetzteil
24VDC, 15Watt,
0,63A, IP20, MM, CE
BxHxL: 40x16x130mm

27,95 €

DR24030

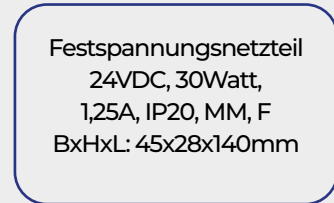

Festspannungsnetzteil
24VDC, 30Watt,
1,25A, IP20, MM, F
BxHxL: 45x28x140mm

33,50 €

DR24060

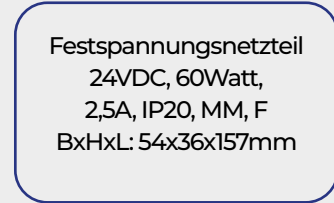

Festspannungsnetzteil
24VDC, 60Watt,
2,5A, IP20, MM, F
BxHxL: 54x36x157mm

57,95 €

DR24100

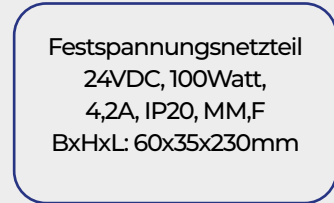

Festspannungsnetzteil
24VDC, 100Watt,
4,2A, IP20, MM, F
BxHxL: 60x35x230mm

91,95 €

DR24150

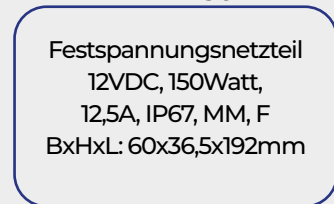

Festspannungsnetzteil
24VDC, 150Watt,
12,5A, IP67, MM, F
BxHxL: 60x36,5x192mm

115,95 €

Slim Line Festspannungsnetzteile für LED

ideal für den Einsatz in Bereichen mit kleinen Einbaumassen

12DC



DR12020

Festspannungsnetzteil
12VDC, 20Watt,
1,67A, IP20, MM
BxHxL: 40x16x130mm

28,50 €

DRS12030



Festspannungsnetzteil
12VDC, 30Watt,
2,5A, IP20, MM,F
BxHxL: 31x17x241mm

37,95 €

DRS12060B



Festspannungsnetzteil
12VDC, 60Watt,
5A, IP20, MM, F
BxHxL: 58x17x241mm

72,95 €

DRS12100



Festspannungsnetzteil
12VDC, 100Watt,
8,33A, IP20, MM,F
BxHxL: 30x18x350mm

99,95 €



24DC

DR24020

Festspannungsnetzteil
24VDC, 20Watt,
0,83A, IP20, MM
BxHxL: 40x16x130mm

28,50 €

DRS24030

Festspannungsnetzteil
24VDC, 30Watt,
1,25A, IP20, MM, F
BxHxL: 31x17x241mm

37,95 €

DRS24060B

Festspannungsnetzteil
24VDC, 60Watt,
2,5A, IP20, MM, F
BxHxL: 58x17x241mm

72,95 €

DRS24100

Festspannungsnetzteil
24VDC, 100Watt,
4,17A, IP20, MM,F
BxHxL: 30x18x350mm

99,95 €

DRS24150

Festspannungsnetzteil
24VDC, 150Watt,
6,25A, IP20, MM,F
BxHxL: 30x18x350mm

135,95 €

DRS24250

Festspannungsnetzteil
24VDC, 250Watt,
10,42A, IP20, MM,F
BxHxL: 40x22x400mm

178,50 €



Extra Slim Line Festspannungsnetzteile für LED ideal für den Einsatz in Bereichen mit sehr kleinen Einbaumassnahmen

IHRE PROBLEMLÖSER

12DC



DRES12060
Festspannungsnetzteil
12VDC, 60Watt,
5A, IP20, SELV, F
BxHxL: 20x20x185(199)mm

83,90 €

DRES12100



Festspannungsnetzteil
12VDC, 96Watt,
8A, IP20, SELV, F
BxHxL: 27x20x199(208)mm

97,80 €

DRES12060K

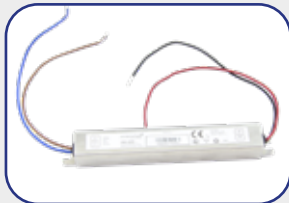

Festspannungsnetzteil
12VDC, 60Watt,
5A, IP20, SELV, F
BxHxL: 20x20x140(160)mm

83,90 €

DRES12100K

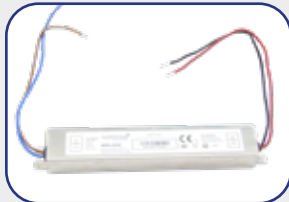

Festspannungsnetzteil
12VDC, 96Watt,
8A, IP20, SELV
BxHxL: 27x20x151(170)mm

97,80 €



24DC

DRES24060

Festspannungsnetzteil
24VDC, 60Watt
2,5A, IP20, SELV, F
BxHxL: 20x20x185(199)mm

83,90 €

DRES24100

Festspannungsnetzteil
24VDC, 96Watt,
4,2A, IP20, SELV,
BxHxL: 27x20x199(208)mm

97,80 €

DRES24060K

Festspannungsnetzteil
24VDC, 60Watt,
2,5A, IP20, SELV, F
BxHxL: 20x20x140(160)mm

83,90 €

DRES24100K

Festspannungsnetzteil
24VDC, 96Watt,
4,2A, IP20, SELV
BxHxL: 27x20x151(170)mm

97,80 €

DRPS24100

Festspannungsnetzteil
Phasen-An-Abschnitt,
24VDC, 100Watt, 4,16A, IP20,
SELV
BxHxL: 30x18x336mm

142,50 €

DRS24250

Festspannungsnetzteil
Phasen-An-Abschnitt,
24VDC, 150Watt, 6,25A, IP20,
SELV
BxHxL: 32x22x357mm

159,95 €



Netzteile dimmbar über Phasen An-/Abschnitt für LED Festspannungsnetzteile

12DC



DRP12040

Festspannungsnetzteil
12VDC, 40Watt,
3,3A, IP20, MM, F
BxHxL: 50x33x156mm

67,95 €



DRP12080

Festspannungsnetzteil
12VDC, 80Watt,
6,67A, IP65, MM, F
BxHxL: 71x47x210mm

209,95 €



DRP12150

Festspannungsnetzteil
12VDC, 150Watt,
12,5A, IP20, MM, F
BxHxL: 54x36x157mm

239,95 €



24DC

DRP24040

Festspannungsnetzteil
24VDC, 40Watt,
1,67A, IP20, MM, F
BxHxL: 50x33x156mm

67,95 €

DRP24060

Festspannungsnetzteil
24VDC, 60Watt,
2,5A, IP20, MM, F
BxHxL: 50x33x166mm

92,95 €

DRP24080

Festspannungsnetzteil
24VDC, 80Watt,
3,33A, IP65, MM, F
BxHxL: 71x47x210mm

209,95 €

DRP24036

Festspannungsnetzteil
24VDC, 36Watt,
1,5A, IP20, MM, F
BxHxL: 43x30x210mm

74,50 €

DRP24075

Festspannungsnetzteil
24VDC, 75Watt,
3,125A, IP20, MM, F
BxHxL: 43x30x293mm

169,50 €

DRP24150

Festspannungsnetzteil
24VDC, 150Watt,
6,25A, IP20, MM, F
BxHxL: 54x36x157mm

239,95 €

Netzteile 5VDC im Metalgehäuse und Spannungsstabilisatoren



DRM05050M

Festspannungsnetzteil
5VDC, 50Watt,
10A, IP20,
BxHxL: 97x36x99mm

67,50 €



DRM05150M

Festspannungsnetzteil
5VDC, 130Watt,
26A, IP20
BxHxL: 98x38x199mm

79,90 €



PANDR05200

Festspannungsnetzteil
5VDC, 200Watt,
40A, IP20,
BxHxL: 110x50x199mm

113,50 €



PANDR05300

Festspannungsnetzteil
5VDC, 300Watt,
60A, IP20,
BxHxL: 115x50x227mm

178,50 €



PANDRS05300

Festspannungsnetzteil
5VDC, 300Watt,
Slim-Line 60A, IP20,
BxHxL: 81,5x31x212mm

199,95 €



DMS-9-12

Mean Well DC-DC-Wandler
15W, Eingang 10,8-13,2
VDC, 1,25A,
Ausgang: 12VDC.

44,50 €

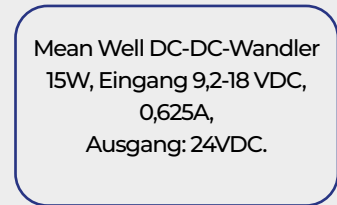

DMS-9-24

Mean Well DC-DC-Wandler
15W, Eingang 9,2-18 VDC,
0,625A,
Ausgang: 24VDC.

44,50 €



DMS-25-12

Mean Well DC-DC-Wandler
25W, Eingang
9,2-18 VDC, 2,1A,
Ausgang: 12VDC.

78,80 €

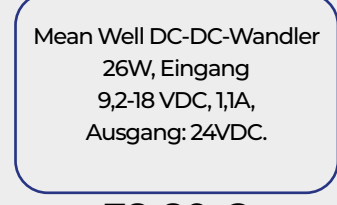

DMS-25-24

Mean Well DC-DC-Wandler
26W, Eingang
9,2-18 VDC, 1,1A,
Ausgang: 24VDC.

78,80 €



DMS-50-12

Mean Well DC-DC-Wandler
50W, Eingang
9,2-18 VDC, 4,2A,
Ausgang: 12VDC.

75,50 €

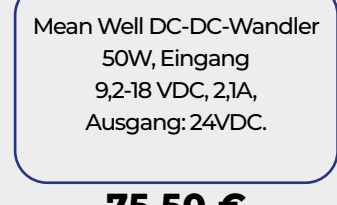

DMS-50-24

Mean Well DC-DC-Wandler
50W, Eingang
9,2-18 VDC, 2,1A,
Ausgang: 24VDC.

75,50 €

Netzteile für Hutschienenmontage



DRM24060HS

Festspannungsnetzteil
24VDC, 60Watt,
2,5A, IP20,
BxHxL: 52,5x90x54,5mm

59,80 €



DRM24120HS

Festspannungsnetzteil
24VDC, 120Watt,
5A, IP20,
BxHxL: 66x100x126mm

91,95 €



DRM24090HS

Festspannungsnetzteil
24VDC, 96Watt,
4A, IP20,
BxHxL: 90x55x100mm

89,50 €



DRM24240HS

Festspannungsnetzteil
24VDC, 240Watt,
10A, IP20,
BxHxL: 63x114x125mm

142,95 €



DRM12120HS

Festspannungsnetzteil
12VDC, 120Watt,
10A, IP20,
BxHxL: 66x100x126mm

91,95 €



DRM24480

Festspannungsnetzteil
24VDC, 480Watt,
20A, IP20,
BxHxL: 100x227x126mm

348,95 €



Konstantstromnetzteile

Netzteile dimmbar über Phasen An-/Abschnitt für LED



DRP-12W0350
 Konstantstromnetzteil
 350mA, 8-12Watt,
 23-35VDC, IP20, MM, F, SELV,
 T10, BxHxL: 42x24x111mm

48,95 €



DRP-12W0700
 Konstantstromnetzteil
 700mA, 8-12Watt,
 IP20, MM, F, T10,
 BxHxL: 39x22x88mm

49,50 €



DRP-20W0500
 Konstantstromnetzteil
 500mA, 12-20Watt,
 24-40VDC, IP20, MM, F, SELV,
 T10, BxHxL: 45x24x132mm

49,50 €



DRP-20W0700
 Konstantstromnetzteil
 700mA, 12-20Watt,
 17-29VDC, IP20, MM, F, SELV,
 T10, BxHxL: 45x24x132mm

49,50 €



DRP-30W0350
 Konstantstromnetzteil
 350mA, 20-30Watt,
 57-86VDC, IP20, MM, F, SELV,
 T10, BxHxL: 50x33x156mm

53,50 €



DRP-30W0700
 Konstantstromnetzteil
 700mA, 15-24Watt,
 21-35VDC, IP20, MM, F, SELV,
 T10, BxHxL: 45x28x140mm

53,50 €



DRP-36W0500
 Konstantstromnetzteil
 500mA, 20-35Watt,
 40-70VDC, IP20, MM, F, SELV,
 T10, BxHxL: 50x33x156mm

53,50 €



DRP-36W0700
 Konstantstromnetzteil
 700mA, 20-35Watt,
 28-50VDC, IP20, MM, F, SELV,
 T10, BxHxL: 50x33x156mm

53,50 €



DRP-36W1000
 Konstantstromnetzteil
 1000mA, 20-35Watt,
 20-35VDC, IP20, MM, F, SELV,
 T10, BxHxL: 50x33x156mm

53,50 €



DRP-36W1400
 Konstantstromnetzteil
 1400mA, 24-36Watt,
 17-26VDC, IP20, MM, F, SELV,
 T10, BxHxL: 50x33x156mm

53,50 €



DRP-50W0700
 Konstantstromnetzteil
 700mA, 33,5-50Watt,
 48-72VDC, IP20, MM, F, SELV,
 T10, BxHxL: 54x36x157mm

53,50 €



DRP-50W1050
 Konstantstromnetzteil
 1050mA, 33,5-50Watt,
 32-48VDC, IP20, MM, F, SELV,
 T10, BxHxL: 54x36x157mm

54,95 €



DRP-50W1400
 Konstantstromnetzteil
 1400mA, 33,5-50Watt,
 24-36VDC, IP20, MM, F, SELV,
 T10, BxHxL: 54x36x157mm

56,50 €

Konstantstromnetzteile einstellbar und Dimmbar über 1-10V oder über push Dim



DRDE-300700

Konstantstromnetzteil-
350mA, 30Watt max.
250-700mA, dim 110 und
push dim.Max. 68VDC, IP20,
MM, SELV, T10,
BxHxL: 67x22x103mm

66,50 €



DRDE-501050

Konstantstromnetzteil-
350mA, 50Watt max.
350-1050mA, dim 110 und
push dim.Max. 68VDC, IP20,
MM, SELV, T10,
BxHxL: 79x24x123mm

79,90 €

Triple Dimm Netzteil Konstantspannungsnetzteil, Triple Dimmbar über Push-Dim (Primärseitig), DALI oder 1-10V



DR12075TD

12VDC, 6,25A, Arbeitsbereich
0-6,25A, IP20,
75VA max
BxHxL: 58x40x220mm

142,50 €



DR24075TD

24VDC, 3,125A, Arbeitsbereich
0-3,125A, IP20,
75VA max.
BxHxL: 58x40x220mm

142,50 €

Festspannungsnetzteile IP67 für LED MEAN WELL NETZTEILE

12DC



DRM12018

Festspannungsnetzteil
12VDC, 18Watt,
1,5A, IP67,
BxHxL: 30x22x140mm

29,95 €

DRM12036



Festspannungsnetzteil
12VDC, 36Watt,
3A, IP67,
BxHxL: 40x30x148mm

38,95 €

DRM12060



Festspannungsnetzteil
12VDC, 60Watt,
5A, IP67,
BxHxL: 43x32x163mm

59,95 €

DRM12100



Festspannungsnetzteil
12VDC, 100Watt,
8,5A, IP67,
BxHxL: 52x37x190mm

119,95 €

DRM12150



Festspannungsnetzteil
12VDC, 132Watt,
11A, IP65,
BxHxL: 68x39x228mm

129,95 €



24DC

DRM24018

Festspannungsnetzteil
24VDC, 18Watt,
0,75A, IP67,
BxHxL: 30x22x140mm

29,95 €

DRM24036

Festspannungsnetzteil
24VDC, 36Watt,
1,5A, IP67,
BxHxL: 40x30x148mm

38,95 €

DRM24060

Festspannungsnetzteil
24VDC, 60Watt,
2,5A, IP67,
BxHxL: 43x32x163mm

59,95 €

DRM24100

Festspannungsnetzteil
24VDC, 100Watt,
4,2A, IP67,
BxHxL: 52x37x190mm

119,95 €

DRM24150

Festspannungsnetzteil
24VDC, 150Watt,
6,3A, IP65,
BxHxL: 68x39x228mm

129,95 €

DRM24480

Festspannungsnetzteil
24VDC, 480Watt,
20A, IP65, SELV
BxHxL: 125x344x262mm

419,90 €

Festspannungsnetzteile IP67 für LED

MEAN WELL NETZTEILE

12DC



DRMF12016

Festspannungsnetzteil
12VDC, 16Watt,
1,34A, IP67, SELV, MM, F,
BxHxL: 40x32x148mm

65,50 €

DRMF12025



Festspannungsnetzteil
12VDC, 25,2Watt,
2,1A, IP67, MM, SELV, F,
BxHxL: 63x37,5x171mm

72,50 €

DRMF12040



Festspannungsnetzteil
12VDC, 40Watt,
3,34A, IP67, SELV, MM, F,
BxHxL: 53x35x150mm

105,95 €

DRMF12060



Festspannungsnetzteil
12VDC, 90Watt,
5A, IP67, MM, SELV, F,
BxHxL: 53x35x150mm

119,95 €

DRMF12090



Festspannungsnetzteil
12VDC, 60Watt,
7,5A, IP67, MM, SELV, F,
BxHxL: 63x37,5x171mm

142,95 €

DRMF12120



Festspannungsnetzteil
12VDC, 120Watt,
10A, IP67, MM, SELV, F,
BxHxL: 52x37x190mm

159,95 €

24DC

DRMF24016



Festspannungsnetzteil
24VDC, 16Watt,
0,67A, IP67, SELV, MM, F,
BxHxL: 40x32x148mm

65,50 €

DRMF24025

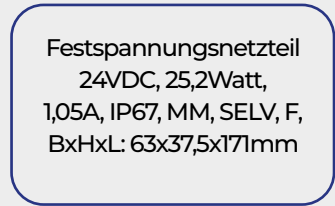

Festspannungsnetzteil
24VDC, 25,2Watt,
1,05A, IP67, MM, SELV, F,
BxHxL: 63x37,5x171mm

72,50 €

DRMF24040

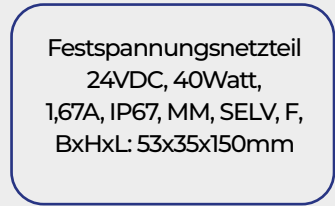

Festspannungsnetzteil
24VDC, 40Watt,
1,67A, IP67, MM, SELV, F,
BxHxL: 53x35x150mm

105,95 €

DRMF24060

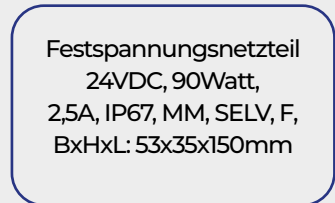

Festspannungsnetzteil
24VDC, 90Watt,
2,5A, IP67, MM, SELV, F,
BxHxL: 53x35x150mm

119,95 €

DRMF24090

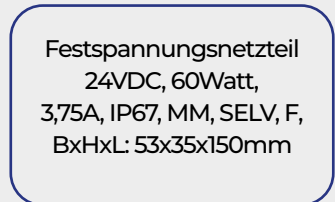

Festspannungsnetzteil
24VDC, 60Watt,
3,75A, IP67, MM, SELV, F,
BxHxL: 53x35x150mm

142,95 €

DRMF24120

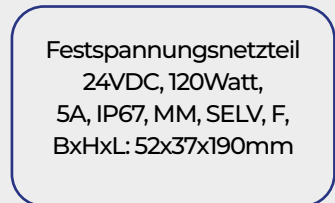

Festspannungsnetzteil
24VDC, 120Watt,
5A, IP67, MM, SELV, F,
BxHxL: 52x37x190mm

159,95 €

Festspannungsnetzteile IP67 für LED dimmbar über DALI

12DC



DRM12075-DALI

Festspannungsnetzteil
12VDC, 60Watt,
5A, IP65, SELV, MM, F,
BxHxL: 63x35,5x180mm

105,95 €

24DC

DRM24075-DALI

Festspannungsnetzteil
24VDC, 75Watt,
3,15A, IP65, SELV, MM, F,
BxHxL: 63x35,5x180mm

105,95 €



DRM24100-DALI

Festspannungsnetzteil
24VDC, 100Watt,
4A, IP65, MM, SELV, F,
BxHxL: 63x35,5x199mm

119,95 €



DRM12150-DALI

Festspannungsnetzteil
12VDC, 120Watt,
10A, IP65, MM, SELV, F,
BxHxL: 63x35,5x219mm

142,95 €

DRM24150-DALI

Festspannungsnetzteil
24VDC, 150Watt,
5A, IP65, MM, SELV, F,
BxHxL: 63x35,5x219mm

142,95 €



DRM12200-DALI

Festspannungsnetzteil
12VDC, 144Watt,
16A, IP65, MM, SELV, F,
BxHxL: 52x37x190mm

159,95 €

DRM24200-DALI

Festspannungsnetzteil
24VDC, 200Watt,
8,4A, IP67, MM, SELV, F,
BxHxL: 52x37x190mm

159,95 €



DRM24240-DALI

Festspannungsnetzteil
24VDC, 240Watt,
12,5A, IP67, SELV, MM, F,
BxHxL: 68x39x228mm

222,00 €

Festspannungsnetzteile IP20 für LED dimmbar über DALI, Push dim und 1-10V



DR12075TD

Festspannungsnetzteil
12VDC, 75Watt,
6,25A, IP20, SELV, F,
BxHxL: 58x40x220mm

142,50 €

DR24075TD

Festspannungsnetzteil
24VDC, 75Watt,
3,125A, IP20, SELV, F,
BxHxL: 58x40x220mm

142,50 €

Festspannungsnetzteile IP67 für LED dimmbar über 1-10V MEAN WELL NETZTEILE

12DC

DRMD12040

Festspannungsnetzteil
12VDC, 40Watt,
3,34A, IP67, SELV, MM, F,
BxHxL: 53x35x150mm

115,50 €

24DC

DRMD24040

Festspannungsnetzteil
24VDC, 40Watt,
1,67A, IP67, MM, SELV, F,
BxHxL: 53x35x150mm

115,50 €

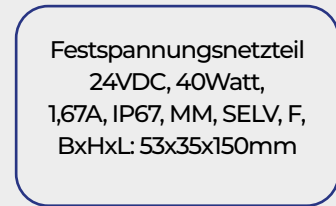

DRMD12060

Festspannungsnetzteil
12VDC, 60Watt,
5A, IP67, MM, SELV, F,
BxHxL: 53x35x150mm

129,95 €

DRMD24060

Festspannungsnetzteil
24VDC, 60Watt,
2,5A, IP67, MM, SELV, F,
BxHxL: 53x35x150mm

129,95 €

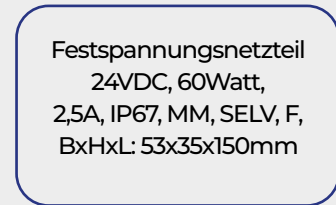

DRMD12090

Festspannungsnetzteil
12VDC, 90Watt,
7,5A, IP67, MM, SELV, F,
BxHxL: 63x37,5x171mm

152,95 €

DRMD24090

Festspannungsnetzteil
24VDC, 90Watt,
3,75A, IP67, MM, SELV, F,
BxHxL: 63x37,5x171mm

152,95 €

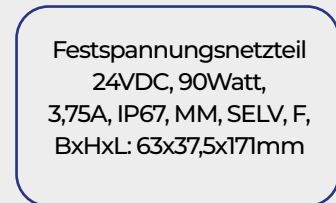

DRMD12120

Festspannungsnetzteil
12VDC, 120Watt,
10A, IP67, MM, SELV, F,
BxHxL: 52x37x190mm

169,95 €

DRMD24120

Festspannungsnetzteil
24VDC, 120Watt,
5A, IP67, MM, SELV, F,
BxHxL: 52x37x190mm

169,95 €

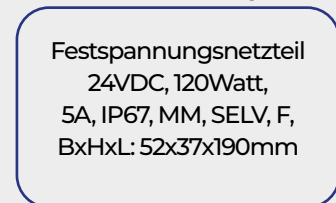

Festspannungsnetzteile IP67 für LED dimmbar über 1-10V MEAN WELL NETZTEILE



12DC

DRMD12150

Festspannungsnetzteil
12VDC, 150Watt,
12,5A, IP67, SELV, MM, F,
BxHxL: 68x39x228mm

209,95 €

24DC

DRMD24150

Festspannungsnetzteil
24VDC, 151Watt,
6,3A, IP67, SELV, MM, F,
BxHxL: 68x39x228mm

209,95 €



DRMD12185

Festspannungsnetzteil
12VDC, 156Watt,
13A, IP67, MM, SELV, F,
BxHxL: 68x39x228mm

229,95 €

DRMD24185

Festspannungsnetzteil
24VDC, 187Watt,
7,8A, IP67, MM, SELV, F,
BxHxL: 68x39x228mm

229,95 €



DRMD12240

Festspannungsnetzteil
12VDC, 192Watt,
16A, IP67, MM, SELV, F,
BxHxL: 68x39x245mm

279,95 €

DRMD24240

Festspannungsnetzteil
24VDC, 240Watt,
10A, IP67, MM, SELV, F,
BxHxL: 68x39x245mm

279,95 €



DRMD12320

Festspannungsnetzteil
12VDC, 256Watt,
22A, IP67, MM, SELV, F,
BxHxL: 90x44x252mm

365,95 €

DRMD24320

Festspannungsnetzteil
24VDC, 320Watt,
13,34A, IP67, MM, SELV, F,
BxHxL: 90x44x252mm

365,95 €



DRMD24480

Festspannungsnetzteil
24VDC, 480Watt,
20A, IP67, MM, SELV, F,
BxHxL: 125x44x262mm

439,90 €



DRMD12600

Festspannungsnetzteil
12VDC, 480Watt,
40A, IP67, SELV, MM, F,
BxHxL: 144x48,5x280mm

539,95 €

DRMD24600

Festspannungsnetzteil
24VDC, 600Watt,
25A, IP67, SELV, MM, F,
BxHxL: 144x48,5x280mm

539,95 €

Weitere Netzteile finden Sie auf unserer Webseite oder Sie fragen bei uns an.

info@nord-star.de | www.nord-star.de

Netzteile

MW-ICL-16L



Einschaltstrombegrenzer 16A,

72,50 €

MW-ICL-16R



Einschaltstrombegrenzer 16A,
für Hutschieneninstallation

72,50 €



Wir bedanken uns für die schönen Bilder, die uns zur Verfügung gestellt wurden und laden Sie zu einen Spaziergang durch Projekte und Inspirationen ein. Einfach scannen und anschauen!



Steuerungen und Dimmer



NLDS-01.08

NORDSTAR Dimmer mit Drehpoti für Monochrome LED-Streifen, 12-24VDC, 8A max., 12V/96Watt max., 24V/198Watt max. IP20. BxHxL: 60x52x90mm

22,50 €



NLDS-01.30

NORDSTAR Dimmer mit Drehpoti für Monochrome LED-Streifen, 12-24VDC, 8A max., 12V/96Watt max., 24V/198Watt max. IP20. BxHxL: 62x35x85mm

44,90 €

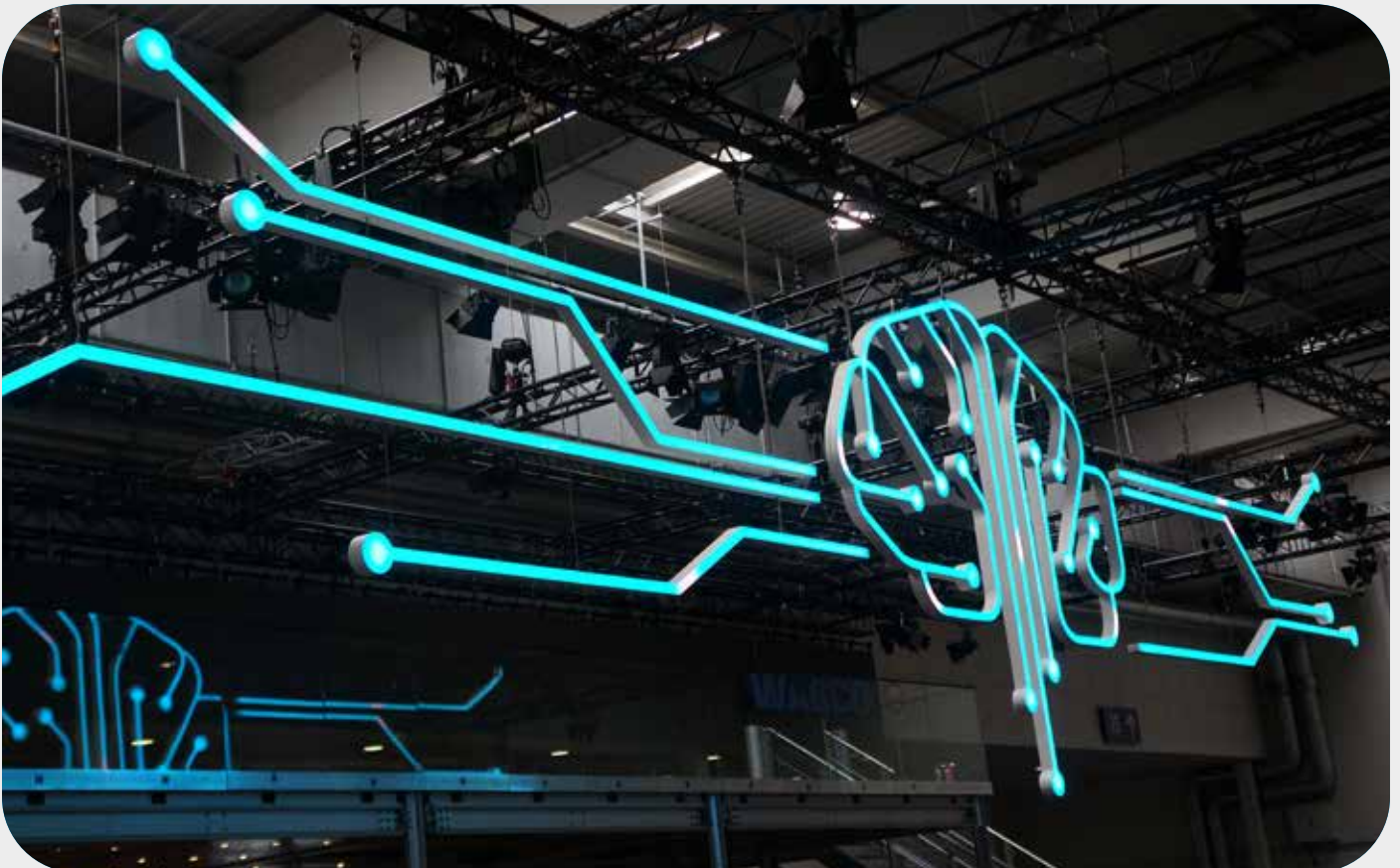

Steuerungen und Dimmer



NLDS-02C

NORDSTAR Dimm Funk-Steuerung, Basisgerät. Eingang 12-36VDC, Sende-Empfangsfrequenz 868MHz, 12V/240 Watt, 24V/480Watt, 4x5A (bei Bedarf können die Ausgangsanschlüsse parallel gebrückt 1x20A), IP20, BxHxL: 20x46x170mm

92,50 €



NLDS-02R

NORDSTAR Funkfernbedienung für Monochrome Steuerung von 6 verschiedenen Zonen sowie gleichzeitige Steuerung der 6 Zonen. Anbindung beliebiger Steuereinheiten NLDS-02C pro Zone. Sende-Empfangsfrequenz 868MHz.

111,95 €



NLDS-02WP

NORDSTAR Monochrom Funk Touch-Panel. Steuerung von beliebig vieler NLDS-02C (Synchron). Lieferung inkl. Netzteil 230VAC/12VDC, IP20. Sendefrequenz 868 Mhz. Reichweite 30 Meter Im Freien max.

199,95 €



Steuerungen und Dimmer



NLDS-03C

NORDSTAR Dimm Funk-Steuerung, Basisgerät. Eingang 12-36VDC, Sendempfangsfrequenz 868MHz, 12V/240 Watt, 24V/480Watt, 4x5A (bei Bedarf können die Ausgangsanschlüsse parallel gebrückt 1x20A), IP20, BxHxL: 20x46x170mm.

92,50 €



NLDS-03R

NORDSTAR Funkfernbedienung für Monochrome Steuerung von 5 verschiedenen Zonen. Anbindung beliebiger Steuereinheiten NLDS-03C pro Zone. Sendempfangsfrequenz 868MHz.

105,95 €



NLDS-03WP

NORDSTAR Monochromes Funk Touch-Panel 5-Kanal. Steuerung von 5 verschiedenen Zonen. Anbindung von beliebig vieler NLDS-03C pro Zone. Lieferung inkl. Netzteil 230VAC/12VDC, IP20. Sendefrequenz 868 Mhz. Reichweite 30 Meter Im Freien max.

199,95 €



Steuerungen und Dimmer



NLDS-04

Touch-Dimmer 04 für Monochrome LED-Streifen, ideal zur Möbeleinbauinstallation. 12/24VDC, 4A max., 12VDC-48Watt
Touch-Dimmer schwarz für Monochrome LED-Streifen max., 24VDC-96Watt max., IP20. In Verbindung mit unseren Leistungsverstärker NLAF-02 können beliebig große Projekte realisiert werden.
BxHxL: 39x9x41mm

39,95 €/Stk.



NLDS-05

Gesten-Schalter 05 für Monochrome LED-Streifen, ideal zur Möbeleinbauinstallation. 12/24VDC, 4A max., 12VDC-48Watt max., 24VDC-96Watt max., IP20. In Verbindung mit unseren Leistungsverstärker NLAF-02 können beliebig große Projekte realisiert werden.
BxHxL: 39x9x41mm

39,95 €/Stk.



NLDS-06W

Touch-Dimmer 06W weiss für Monochrome LED-Streifen ideal zur Möbeleinbauinstallation, 12/24VDC, 4A max., 12VDC-48Watt max., 24VDC-96Watt max., IP20 In Verbindung mit unseren Leistungsverstärker NLAF-02 können beliebig große Projekte realisiert werden.
BxH: 22(18)x17mm

39,95 €/Stk.



NLDS-06B

Touch-Dimmer 06B schwarz für Monochrome LED-Streifen, ideal zur Möbeleinbauinstallation, 12/24VDC, 4A max., Dimmer mit Touch Funktion für Monochrome LED-Streifen. 12VDC-48Watt max., 24VDC-96Watt max., IP20. In Verbindung mit unseren Leistungsverstärker NLAF-02 können beliebig große Projekte realisiert werden.
BxH: 22(18)x17mm

39,95 €/Stk.



NLDS-07

Touch-Dimmer 07, zum verlöten. 12/24VDC, 8A max., 12VDC-96Watt max., 24VDC-198Watt max., IP20. In Verbindung mit unseren Leistungsverstärker NLAF-02 können beliebig große Projekte realisiert werden.
BxHxL: 10x8(bis 23)x43,5x mm

39,95 €/Stk.

Steuerungen und Dimmer



NLDS-08

Touch-Dimmer 08 weiß für Monochrome LED-Streifen ideal zur Möbeleinbauinstallation, kann hinter Glas oder Holz montiert werden (max. 25mm starkes Holz). 12/24VDC, 4A max., 12VDC-48Watt max., 24VDC-96Watt max., IP20. In Verbindung mit unseren Leistungsverstärker NLAf-02 können beliebig große Projekte realisiert werden.
BxHxL: 38x7x38mm

47,00 €/Stk.



NLDS-09

Touch-Dimmer 09 für Monochrome LED-Streifen, ideal zur Möbeleinbauinstallation, kann hinter Glas montiert werden (max. 5mm starkes Glas oder Spiegel). 12/24VDC, 4A max., 12VDC-48Watt max., 24VDC-96Watt max., IP20. In Verbindung mit unseren Leistungsverstärker NLAf-02 können beliebig große Projekte realisiert werden.
BxHxL: 38x7x38mm

47,00 €/Stk.



NLDS-10

Touch-Dimmer 10 für Monochrome LED-Streifen, ideal zur Möbeleinbauinstallation, kann in Aluminiumprofil montiert werden (nur in dafür vorgesehene Profile). Dimmen über touch auf dem Profil. 12/24VDC, 3A max., 12VDC-36Watt max., 24VDC-72Watt max., IP20. In Verbindung mit unseren Leistungsverstärker NLAf-02 können beliebig große Projekte realisiert werden.
BxHxL: 10x4x55mm

39,95 €/Stk.



NLLS-01

LED-Lichtsensor/Türschalter 01, weiss für Monochrome LED-Streifen, ideal zur Möbel-/Kücheninstallation, 12/24VDC, 3A max., 12VDC-36Watt max., 24VDC-72Watt max., IP20, 1Meter Kabel und 2x25cm Anschlusskabel mit Anschlusskupplung für den Eingang und Anschlussstecker für den Ausgang, In Verbindung mit unseren Leistungsverstärker NLAf-02 können beliebig große Projekte realisiert werden.

BxHxL: 12x12mm.

39,95 €/Stk.

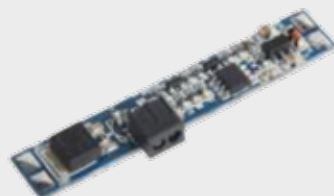

NLLS-02

NLLS-02 LED-Lichtsensor/Türschalter 02 für Monochrome LED-Streifen, ideal zur Möbel-/Kücheninstallation, 12/24VDC, 8A max., 12VDC-96Watt max., 24VDC-192Watt max., IP20, zum anlöten, In Verbindung mit unseren Leistungsverstärker NLAf-02 können beliebig große Projekte realisiert werden.

BxHxL: 10x4x55mm.

39,95 €/Stk.



NLLS-03

NLLS-03 LED-Lichtsensor/Türschalter 03 für Monochrome LED-Streifen, ideal zur Möbel-/Kücheninstallation, 12/24VDC, 4A max., 12VDC-48Watt max., 24VDC-96Watt max., IP20, 1Meter Kabel für die Sensoren und 2x25cm Anschlusskabel mit Anschlusskupplung für den Eingang und Anschlussstecker für den Ausgang, In Verbindung mit unseren Leistungsverstärker NLAf-02 können beliebig große Projekte realisiert werden.

DxT: 11x18mm

47,95 €/Stk.

Steuerungen und Dimmer



NLMC-01C

NORDSTAR Funk-Steuerung Multi-Color (RGB-RGB/W) Funk-Steuerung, Basisgerät. Sende- Empfangsfrequenz 868MHz, Eingang 12-36VDC, 12V/240Watt, 24V/480Watt, 4x5A, IP20, BxHxL: 20x46x170mm.

92,50 €/Stk.



NLMC-01R

NORDSTAR Funkfernbedienung für RGB bzw. RGB/W Steuerung von 6 verschiedenen Zonen sowie gleichzeitige Steuerung der 6 Zonen. Anbindung beliebiger Steuereinheiten NLMC-01C pro Zone. Sende-Empfangsfrequenz 868MHz.

115,95 €/Stk.



NLMC-01WP

NORDSTAR RGB-RGB/W Funk-Touch-Panel. Steuerung von beliebig vieler NLMC-01C (Synchron). Lieferung inkl. Netzteil 230VAC/12VDC, IP20. Sendefrequenz 868 Mhz, Reichweite 30 Meter im Freien max.

199,95 €/Stk.



NLMC-06 set

Nordstar NLMC-06, LED-Multicolor Funkfernbedienung für RGB-RGB/W LED-Streifen, Basisgerät mit Funkfernbedienung. Steuerung von einem Bereich. Sendefrequenz 868 MHz, Reichweite max. 30Meter im Freien.

49,95 €/Stk.



Steuerungen und Dimmer



NLBI-01C

NORDSTAR Bi-Color Funk-36VDC, Sende-Empfangsfrequenz 868MHz, 12V/192Watt, 24V/394Watt, IP20, BxHxL: 20x46x170mm

92,50 €/Stk.



NLBI-01R

NORDSTAR Funkfernbedienung für Bi-Color Steuerung von 6 verschiedenen Zonen sowie gleichzeitige Steuerung der 6 Zonen. Anbindung beliebiger Steuereinheiten NLBI-01C pro Zone. Sende-Empfangsfrequenz 868MHz.

115,95 €/Stk.



NLBI-01WP

NORDSTAR Bi-Color Funk Touch-Panel. Steuerung von beliebig vieler NLBI-01C. Lieferung inkl. Netzteil 230VAC/12VDC, IP20. Sendefrequenz 868 MHz, Reichweite 30 Meter im Freien BxHxL: 86x86xmm

199,95 €/Stk.



Steuerungen und Dimmer



NLDALID-1K

NORDSTAR Steuerung mit DALI Schnittstelle, 1Kanal. Eingang, 12-24V-DC, 36-48VDC, 12/24V=15A, 36-48V=10A, 12V/240Watt, 24V/480Watt, 36V/360W, 48V/480W, IP20

BxHxL: 45x27x175mm

105,50 €/Stk.



NLDALI-4K

NORDSTAR Steuerung mit DALI Schnittstelle, 4Kanal. Eingang 12- 36VDC, 12V/240Watt, 24V/480Watt, 4x5A, IP20,

BxHxL: 20x46x170mm

115,50 €/Stk.



NLDALI-4KH

NORDSTAR Steuerung mit DALI Schnittstelle, 4Kanal. Eingang 12- 24VDC, 12V/240Watt, 24V/480Watt, 4x5A, IP20, für Hutschiene

BxHxL: 48x67x110mm

115,50 €/Stk.



NLDSM-01

Mean Well Dimmsteuerung, Betriebsspannung 240VAC, Steuerbar über DALI oder Push Dimm Steuerarten, DALI auf PWM, vier adressierbare DALI Ausgänge DALI Standard (IEC62386-101, 102, 207), Dimmbereich 1-100%, Ein-/Ausschaltung über Push dim.

BxHxL: 46x23x165mm

69,00 €/Stk.



NL110-1K

NORDSTAR Steuerung mit 1-10V Schnittstelle, 1Kanal. Eingang 12-36VDC, 12V/240Watt, 24V/480Watt, 4x5A, IP20,

BxHxL: 20x46x170mm

119,95 €/Stk.



NL110-4K

NORDSTAR Steuerung mit 1-10V Schnittstelle, 4Kanal. Eingang 12-36VDC, 12V/240Watt, 24V/480Watt 4x5A.

BxHxL: 20x46x170mm

129,95 €/Stk.



Steuerungen und Dimmer

Steuerungen mit Köpfchen



- Einfache Steuerung über Bluetooth 4.0
- Zeitgesteuerte-Automatisierte Lichtbedienung
- Fernsteuerung möglich
- Individuelle Lichtprogrammierung
- Gastzugang
- Einfache Bedienung über Lichtschalter
- Kollektive Anbindung / Reichweiten-Erweiterung

Bluetooth



NLCB-01.D01 Dali 1Kanal

4in1 Casambi Universal Modul zur Lichtsteuerung/-regulierung via Smartphone oder Tablet über Bluetooth. Individuell programmierbar für monochrome-, bicolor-, RGB oder RGB/W Streifen. In Verbindung mit unseren LED-Steuerungen mit DALI-Schnittstelle oder 1-10V.

129,95 €



NLCB-01.D02 Dali 2Kanal

4in1 Casambi Universal Modul zur Lichtsteuerung/-regulierung via Smartphone oder Tablet über Bluetooth. Individuell programmierbar für monochrome-, bicolor-, RGB oder RGB/W Streifen. In Verbindung mit unseren LED-Steuerungen mit DALI-Schnittstelle oder 1-10V.

129,95 €



NLCB-01.D03 Dali 3Kanal

4in1 Casambi Universal Modul zur Lichtsteuerung/-regulierung via Smartphone oder Tablet über Bluetooth. Individuell programmierbar für monochrome-, bicolor-, RGB oder RGB/W Streifen. In Verbindung mit unseren LED-Steuerungen mit DALI-Schnittstelle oder 1-10V.

129,95 €



NLCB-01.D04 Dali 4Kanal

4in1 Casambi Universal Modul zur Lichtsteuerung/-regulierung via Smartphone oder Tablet über Bluetooth. Individuell programmierbar für monochrome-, bicolor-, RGB oder RGB/W Streifen. In Verbindung mit unseren LED-Steuerungen mit DALI-Schnittstelle oder 1-10V.

129,95 €



NLCB-01.110 1-10V 1Kanal

4in1 Casambi Universal Modul zur Lichtsteuerung/-regulierung via Smartphone oder Tablet über Bluetooth. Individuell programmierbar für monochrome-, bicolor-, RGB oder RGB/W Streifen. In Verbindung mit unseren LED-Steuerungen mit DALI-Schnittstelle oder 1-10V.

129,95 €

Steuerungen und Dimmer Steuerungen mit Köpfchen

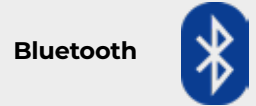
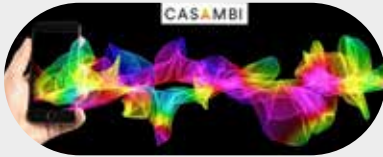

NLCB-4K

4Kanal Casambi-Modul mit integrierter Steuerung. Ideal zum steuern von RGB/W Streifen oder 4 einzelner Lichtquellen.

149,95 €



NLCB-240

Casambi Steuerung für 230VAC. Ideal zur Steuerung von dimmbaren Lampen oder Netzteilen.

129,95 €



NLCB-E27A

Steuerung integriert Casambi E27 Fassung für Dimmbare Lampen bis 50 Watt Type A

159,95 €



NLCB-E27B

Steuerung integriert Casambi E27 Fassung für Dimmbare Lampen bis 50 Watt Type B

159,95 €



NLCB-E27C

Steuerung integriert Casambi E27 Fassung für Dimmbare Lampen bis 50 Watt Type C

159,95 €



Steuerungen und Dimmer

Steuerungen mit Köpfchen

CASAMBI

Bluetooth



NLCB-WPB

Casambi Touch-Panel (schwarz) zur Steuerung von bis zu vier Monochromer Controller

315,95 €



NLCB-WPW

Casambi Touch-Panel (weiß) zur Steuerung von bis zu vier Monochromer Controller

315,95 €



NLCB-4T

NLCB-4T Casambi 4Kanal Taster via Bluetooth. Zum Schalten von vier LED-Monochromen Casambi-Modulen oder von vier einzelnen Farben. Auch das Dimmen ist möglich. Kein Stromanschluss und auch keine Batterie nötig. IP20. Einsetzbar in vielen Schalterprogrammen. BxHxL: 81x81x1,5mm

160,00 €



NLCB-BHSg

Casambi Sensor (grau). Individuell programmierbar. Steuerung von Modulen bei Helligkeitsänderung und bei Bewegung.

342,50 €



NLCB-BHSw

Casambi Sensor (weiß). Individuell programmierbar. Steuerung von Modulen bei Helligkeitsänderung und bei Bewegung.

342,50 €



NLCB-BHSb

Casambi Sensor (schwarz). Individuell programmierbar. Steuerung von Modulen bei Helligkeitsänderung und bei Bewegung.

342,50 €

Steuerungen und Dimmer

Leistungsverstärker



NLA-F-01

NORDSTAR Leistungsverstärker Dreikanal. 3X4A oder 1x 12A bei entsprechender Verdrahtung. 12- 24VDC, 12V/144Watt, 24V/288Watt, IP20. Überhitzungs- und Kurzschlusschutz. Mit der entsprechenden Anzahl von NLA-F01 können beliebig große Dreikanal Licht-Objekte realisier werden.
BxHxL :64x23x115mm

92,50 €



NLA-F-02B

NORDSTAR Leistungsverstärker Vierkanal. 4X8A oder 32A bei entsprechender Verdrahtung. 12- 24VDC, 12V/384Watt, 24V/768Watt, IP20. Überhitzungs- und Kurzschlusschutz. Mit der entsprechenden Anzahl von NLA-F02B können beliebig große Licht-Objekte realisier werden.
BxHxL :64x23x115mm

115,95 €



NLA-F-03

NORDSTAR Leistungsverstärker Fünfkanal. 5X5A oder 1x 25A bei entsprechender Verdrahtung. 12-24VDC, 12V/300Watt 24V/600Watt, IP20. Überhitzungs- und Kurzschlusschutz. Mit der entsprechenden Anzahl von NLA-F03 können beliebig große Licht-Objekte realisiert werden.
BxHxL :46x20x170mm

129,50 €



NLDMX-02

DMX-Steuerung 4 Kanal
12-24VDC, 12VDC- 240VA, 24VDC- 480VA
4x5A, IP20, Überhitzungs- und Kurzschluss-
schutz Mit der entsprechenden Anzahl von
NLA-F02B können beliebig große Licht-Objekte
realisiert werden.
BxHxL :46x20x170mm

129,50 €



NLDMX-02-4KH

DMX-Steuerung 4 Kanal für Hutschiene,
12-24VDC, 12VDC- 240VA, 24VDC- 480VA 4x5A
IP20, Überhitzungs- und Kurzschlusschutz
Mit der entsprechenden Anzahl von NLA-F02B
können beliebig große Licht-Objekte
realisiert werden.
BxHxL: 48x67x110mm

139,95 €

Steuerungen und Dimmer
NLaio-01 die intelligente Steuerung
für alle LED-Streifentypen.
Mit ALEXA oder ZigBee Anbindungsmöglichkeit



NLaio-01c

NLaio WiFi / Funksteuerung. 5x3A, max. 15A, 12VDC - 5x 36W, 24VDC - 5x72W.
 Anbindung ins eigene W-Lan Netz
 BxHxL: 38x20x114mm

124,95 €



NLaio-01z

NLaio ZigBee / Funksteuerung. 5x3A, max. 15A, 12VDC - 5x 36W, 24VDC - 5x72W Bluetooth Signal
 BxHxL: 38x20x114mm

124,95 €



NLaio-DS01R

Nordstar "All In One" Funkfernbedienung für Monochromen LED-Lichtquellen, 8 Zonen.
 Magnetisch und mit Halterung.

BxHxL: 53x17,5x122mm

115,95 €



NLaio-DS01WP

Nordstar "All In One" Funk-Wand-Panel (weiß) für Monochromen LED-Lichtquellen, 4 Zonen.
 Funk- oder DMX.

BxHxL: 86x86x36,5mm

209,95 €



NLaio-DS02WP

Nordstar "All In One" Funk-Wand-Panel (schwarz) für Monochromen LED-Lichtquellen, 4 Zonen.
 Funk- oder DMX

BxHxL: 86x86x36,5mm

209,95 €

Steuerungen und Dimmer



NLaio-Bi01R

Nordstar "All In One" Funkfernbedienung für Bi-Color (TW) LED-Lichtquellen, 4 Zonen.
Magnetisch und mit Halterung.

BxHxL: 53x17,5x122mm

115,95 €



NLaio-Bi01WP

Nordstar "All In One" Funk-Wand-Panel (weiß) für Bi-Color (TW) LED-Lichtquellen, 4 Zonen.
Funk- oder DMX

BxHxL: 86x86x36,5mm

209,95 €



NLaio-Bi01WP

Nordstar "All In One" Funk-Wand-Panel (schwarz) für Bi-Color (TW) LED-Lichtquellen, 4 Zonen.
Funk- oder DMX

BxHxL: 86x86x36,5mm

209,95 €



NLaio-MC01R

Nordstar "All In One" Funkfernbedienung für RGB LED-Lichtquellen, 4 Zonen.
Magnetisch und mit Halterung.

BxHxL: 53x17,5x122mm

115,95 €



NLaio-MC01WP

Nordstar "All In One" Funk-Wand-Panel (weiß) für RGB LED-Lichtquellen, 4 Zonen.
Funk- oder DMX

BxHxL: 86x86x36,5mm

209,95 €



NLaio-MC02WP

Nordstar "All In One" Funk-Wand-Panel (schwarz) für RGB LED-Lichtquellen, 4 Zonen.
Funk- oder DMX

BxHxL: 86x86x36,5mm

209,95 €

Steuerungen und Dimmer



NLaio-MW01R

Nordstar "All In One" Funkfernbedienung für RGB/W LED-Lichtquellen, 4 Zonen. Magnetisch und mit Halterung.

BxHxL: 53x17,5x122mm

115,95 €



NLaio-MW01WP

Nordstar "All In One" Funk-Wand-Panel (weiß) für RGB/W LED-Lichtquellen, 4 Zonen. Funk- oder DMX

BxHxL: 86x86x36,5mm

209,95 €



NLaio-MW02WP

Nordstar "All In One" Funk-Wand-Panel (schwarz) für RGB/W LED-Lichtquellen, 4 Zonen. Funk- oder DMX

BxHxL: 86x86x36,5mm

209,95 €



NLaio-MB01R

Nordstar "All In One" Funkfernbedienung für RGB-Bi-Color (TW) LED-Lichtquellen, 4 Zonen. Magnetisch und mit Halterung.

BxHxL: 53x17,5x122mm

115,95 €



NLaio-MB01WP

Nordstar "All In One" Funk-Wand-Panel (weiß) für RGB-Bi-Color (TW) LED-Lichtquellen, 4 Zonen. Funk- oder DMX

BxHxL: 86x86x36,5mm

209,95 €



NLaio-MB02WP

Nordstar "All In One" Funk-Wand-Panel (schwarz) für RGB-Bi-Color (TW) LED-Lichtquellen, 4 Zonen. Funk- oder DMX

BxHxL: 86x86x36,5mm

209,95 €

Steuerungen und Dimmer



NLaio-WiFi01

NLaio WiFi Funkbrücke.
Anbindung ins eigene W-Lan Netz

DxH: 72x25mm

148,95 €



NLAF-03

NORDSTAR Leistungsverstärker Fünfkkanal. 5x5A oder 1x 25A bei entsprechender Verdrahtung. 12- 24VDC, 12V/300Watt, 24V/600Watt, IP20. Überhitzungs-, Überlast und Kurzschlusschutz. Mit der entsprechenden Anzahl von NLAF-03 können beliebig große Licht-Objekte realisiert werden.

BxHxL: 75x24,5x107mm

139,90 €



NLMODST-DIG



Steuerung für
Digitale LED-Straeifen oder
LED-Module 1 Kanal
mit vorprogrammierten
Szenen

67,80 €

NLMC-DIG



Steuerung für
Digitale LED-Straeifen oder
LED-Module 1 Kanal
Programmierbar

99,00 €

NLMC-DIG16



Steuerung für
Digitale LED-Straeifen oder
LED-Module 16Kanal
Programmierbar

519,90 €

Steuerungen und Dimmer

SHD-125



Unterputz LED Dimmer , Dimmtyp: Phase, MICRO SHD-125, 34x34x11mm, 230V 50Hz, dimmt bis zu 125W (kapazitive Last / LED), benötigt KEINEN N-Leiter, passt in die 68er Schalterdose
69,95 €

DIM-02-150



Digitaler LED Druck- Aus/ Wechseldimmer ECO150, 150W LED max, phasenabschnitt , geräuschlos dimmbar, mit Überlastschutz und Entstörfilter, Einstellung MIN Dimmbarkeit
79,50 €

DIM-03-500



Digitaler LED Druck- Aus/ Wechseldimmer ECO500, 500W LED max, phasenabschnitt , geräuschlos dimmbar, mit Überlastschutz und Entstörfilter, Einstellung MIN/MAX Dimmbarkeit
98,50 €

DIM-04-200



Tastergesteuerter Unterputz LED Dimmer, 100-240V AC Eingangs und Ausgangsspannung, 45x45,5x20,3mm bis zu 200W (kapazitive Last / LED), E eingang für Push Dim Funktion
95,20 €

BMEBGB-01



Deckeneinbaumelder 360° IP20, weiß, IR, Erfassungsbereich Ø 8m, Montagehöhe: 2,2 - 4m, IP20, 300W max (LED), Lichtsensor-Empfindlichkeit 10 - 2000lux, 10 Sekunden bis 15 Minuten Haltezeit
78,30 €

BMEBGB-02W



Bewegungsmelder IR, reinweiß glänzend , Relais-Technik - 3-Leiter-Anschluss, Erfassungsbereich 180°, 6 m, Dämmerungssensor stufenlos einstellbar

137,50 €

BMABGB-01B



Decke/Wand/Eck Bewegungsmelder, schwarz, Erfassungsbereich Ø 12m, Montagehöhe: 1,8 - 2,5m, IP44, 300W max (LED), Lichtsensor-Empfindlichkeit 10 - 2000lux, 10 - 240 Sekunden, inkl. Ecksockel, schlagfestes Polycarbonat, 5 Jahre Herstellergarantie

113,90 €

BMABGB-01W



Decke/Wand/Eck Bewegungsmelder, weiß, Erfassungsbereich Ø 12m, Montagehöhe: 1,8 - 2,5m, IP44, 300W max (LED), Lichtsensor-Empfindlichkeit 10 - 2000lux, 10 - 240 Sekunden, inkl. Ecksockel, schlagfestes Polycarbonat, 5 Jahre Herstellergarantie

113,90 €

BMABGB-02W



Bewegungsmelder Züblin INFRA GARDE 200° weiß

103,50 €

BMABGB-03W



Bewegungsmelder Züblin AP SWISS GARDE 360 30m

Optional mit Funkfernbedienung zum einstellen der Parameter

177,50 €

BMEBGB-03W



Bewegungsmelder Züblin UP SWISS GARDE 360plus RA
Optional mit Funkfernbedienung zum einstellen der Parameter

157,50 €

NLBM-01B



Bewegungsmelder IR (schwarz) für LED-Streifen mit einstellbarer Zeiteinstellung, 1-10Min., 8Meter Reichweite, 12/24VDC 96/192 Watt, 8A max., IP20, BxHxL: 75x46x34mm

39,95 €

NLBM-01W



Bewegungsmelder IR (weiß) für LED-Streifen mit einstellbarer Zeiteinstellung, 1-10Min., 8Meter Reichweite, 12/24VDC 96/192 Watt, 8A max., IP20, BxHxL: 75x46x34mm

39,95 €

NLCB-BHS(x)



Casambi Sensor (in ws, br). Individuell programmierbar. Steuerung von Modulen bei Helligkeitsänderung und bei Bewegung.

342,50 €

BMFB-01Z



Profi - Handsender für Bewegungsmelder ZÜBLIN.

34,90 €

Werbetechnik

Module zum bestücken von Werbeschrift.



NLMOL-01HP
High-Power LED-Modul, 1,5W, 2835SMD, 120lm, Einzel-LED, kalt-weiß

6,30 €/Stk.



NLMOL-02HP
High-Power LED-Modul, 2,8W, 3535SMD, 210lm, Einzel-LED, kalt-weiß

12,80 €/Stk.



NLMOL-28ww
3-fach LED-Modul, 2835SMD, warm-weiß

2,70 €/Stk.



NLMOL-28cw
3-fach LED-Modul, 2835SMD, kalt-weiß

2,70 €/Stk.



NLMOL-28rt
3-fach LED-Modul, 2835SMD, Rot

2,70 €/Stk.



NLMOL-28gn
3-fach LED-Modul, 2835SMD, Grün

2,70 €/Stk.



NLMOL-28bl
3-fach LED-Modul, 2835SMD, Blau

2,70 €/Stk.



NLMOL-01L
LED-Modul Einzelne LED, 2835SMD, 0,36W mit Linse, kalt-weiß, IP67

3,20 €/Stk.



NLMOL-50ww
3-fach LED-Modul, 5050SMD, IP65, warm-weiß

3,20 €/Stk.



NLMOL-50cw
3-fach LED-Modul, 5050SMD, IP65, kalt-weiß

3,20 €/Stk.



NLMOL-50rt
3-fach LED-Modul, 5050SMD, IP65, Rot

3,20 €/Stk.



NLMOL-50gn
3-fach LED-Modul, 5050SMD, IP65, Grün

3,20 €/Stk.



NLMOL-50bl
3-fach LED-Modul, 5050SMD, IP65, Blau

3,20 €/Stk.



NLMOL-50mc
3-fach LED-Modul, 5050SMD, IP65, Multi-Color

3,20 €/Stk.

Werbetechnik

Module zum bestücken von Werbeschrift.



NLMOL-57ww

3-fach LED-Modul mit
Linse, 5730SMD, IP67,
warm-weiß

4,50 €/Stk.



NLMOL-57cw

3-fach LED-Modul mit
Linse, 5730SMD, IP67,
kalt-weiß

4,50 €/Stk.



NLMOL-57rt

3-fach LED-Modul mit
Linse, 5730SMD, IP67, Rot

4,50 €/Stk.



NLMOL-57ge

3-fach LED-Modul mit
Linse, 5730SMD, IP67,
Gelb

4,50 €/Stk.



NLMOL-57li

3-fach LED-Modul mit
Linse, 5730SMD, IP67, Lila

4,50 €/Stk.



NLMOL-57bl

3-fach LED-Modul mit
Linse, 5730SMD, IP67,
Blau

4,50 €/Stk.

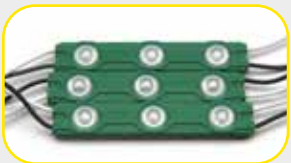

NLMOL-57gn

3-fach LED-Modul mit
Linse, 5730SMD, IP67,
Grün

4,50 €/Stk.



NLMODST-dig

Modul-Steuerung für
NLMOD-03dig

49,00 €/Stk.



NLMOD-03dig

3-fach LED-Modul mit
Linse, 5730SMD, IP67,
digital

6,90 €/Stk.

Werbetechnik

LED-Platinen zum hinterleuchten von stoffbezogenen Werbetafeln.

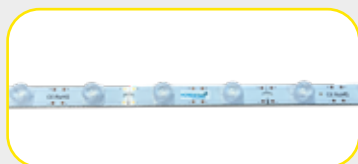

LPMOL-01HP

LED-Modul High Power
mit Linse, High power led
1.5W(Epistar), 24VDC, 65°
Abstrahlwinkel, IP20.
BxHxL: 15x25x1000mm

77,35 €/Stk.



Leuchten und Spots Downlights Vario K

NDL-07VK



NDL-07VK Downlight, 7Watt, 590lm
84lm/W, 90° Abstrahlwinkel, Vario Kelvin
Einstellbare Lichtfarbe in 3000K, 4000K
oder 6500K

BxH : 68-85x57mm

30,50 €/Stk.

NDL-10VK



NDL-10VK Downlight, 10Watt, 800lm,
80lm/W, 90° Abstrahlwinkel, Vario Kelvin.
Einstellbare Lichtfarbe in 3000K, 4000K
oder 6500K

BxH : 90-103x59mm

45,20 €/Stk.

NDL-14VK



NDL-14VK Downlight, 14Watt, 1260lm
90lm/W, 90° Abstrahlwinkel, Vario Kelvin
Einstellbare Lichtfarbe in 3000K, 4000K
oder 6500K

BxH : 120-135x66mm

50,95 €/Stk.

NDL-17VK



NDL-17VK Downlight, 14Watt, 14280lm,
84lm/W, 90° Abstrahlwinkel, Vario Kelvin.
Einstellbare Lichtfarbe in 3000K, 4000K
oder 6500K

BxH : 145-164x69mm

59,95 €/Stk.

NDL-25VK



NDL-25VK Downlight, 25Watt, 21000lm,
84lm/W, 90° Abstrahlwinkel, Vario Kelvin.
Einstellbare Lichtfarbe in 3000K, 4000K
oder 6500K

BxH : 194-234x84mm

66,95 €/Stk.



NDL-SI07	Downlight-Blende silber gebürstet für Downlight NDL-07VK	6,50 €/Stk.
NDL-SI10	Downlight-Blende silber gebürstet für Downlight NDL-10VK	7,20 €/Stk.
NDL-SI14	Downlight-Blende silber gebürstet für Downlight NDL-14VK	7,70 €/Stk.
NDL-SI17	Downlight-Blende silber gebürstet für Downlight NDL-17VK	8,30 €/Stk.
NDL-SI25	Downlight-Blende silber gebürstet für Downlight NDL-25VK	8,95 €/Stk.

Leuchten und Spots Downlights DimToWarm

Moon

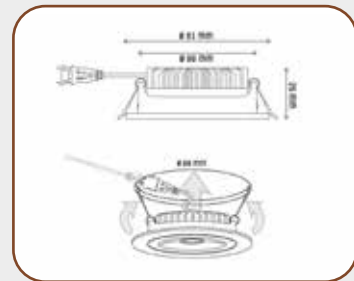
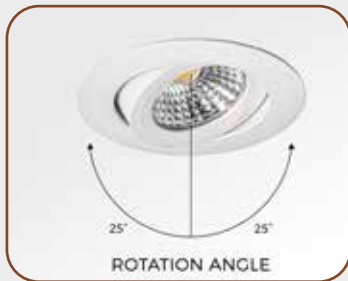

NDL-DTW-01W	Downlight weiß Dim-To-Warm	54,15 €/Stk.
NDL-DTW-01S	Downlight silber gebürstet Dim-To-Warm	54,15 €/Stk.
NDL-DTW-01B	Downlight schwarz Dim-To-Warm	54,15 €/Stk.

MOON Einbauspot Ø68 dim to warm, 350lm, weiß, schwarz oder silber.

DIM TO WARM: beim Dimmen fällt die Lichttemperatur von 2700K auf wohlfühlende 2000K, Entblendet: UGR<19, 60° Abstrahlwinkel, CR<95, IP44, für

Lochmaße Ø68mm), schwenkbar bis 25°, Außendurchmesser Ø81mm, H25mm, inkl. externem flickerfreiem Treiber, Marken - Chips von Bridgelux, inkl.

Anschlussbox mit durchgangsverdrahtbaren Leuchtenklemmen, Material Aluminium, 65.000h (L80B10), 100.000h (L70/50).



AUFSTELLER MOON

In Kooperation mit Merten und Eltako kann die einfache und unkomplizierte Bedienung der Dim To Warm Downlights NDL-DTW-01 präsentiert werden. Mit einer Anschlussleitung von 1,5m kann der Aufsteller sofort in Betrieb genommen werden.

Die Kombination von Eltako EUD-61NPN-230V (Phasendimmung), dem Merten Taster (System M Thermoplast brilliant) und unserem Moon Downlight Dim To Warm, ist die perfekte Einheit für hohe Ansprüche.

Leuchten und Spots

NDLS-01



Downlight F-TYPE II IP66 6W/660lm,
feuerfest nach EN 1363-1, inkl.
Anschlussbox, weiß, DA 68-75mm, AD
84mm, Einbautiefe 37mm, flickerfrei,
dimmbar über Phase, Lichtfarbe
einstellbar, -10°C ~ +45°C, 35.000h

53,95 €

NLGU-10-xx



GU10, Leuchtmittel,
in verschiedenen
Variationen .
4,9W, 6,5W, 7W
in warmweiß oder
neutralweiß

Auf Anfrage

NLGU-10-xx



GU10, Leuchtmittel,
in verschiedenen
Variationen .
4,9W, 6,5W, 7W
in warmweiß oder
neutralweiß

Auf Anfrage

NLLMGB-D05ww



LED-Leuchtmittel mit
Leuchtenklemme 5W
3000K, dimmbar , extra
flach (35mm) als Ersatz
für GU10 Leuchtmittel, mit
Linsenoptik, 400lm

14,00 €

NLLMGB-D05nw



LED-Leuchtmittel mit
Leuchtenklemme 5W
4000K, dimmbar , extra
flach (35mm) als Ersatz
für GU10 Leuchtmittel, mit
Linsenoptik, 400lm

14,00 €

NLGBSP-01al



Spot, 68ø, schwenkbar,
alu glänzend

14,40 €

NLGBSP-01ws



Spot, 68ø, schwenkbar,
weiß

14,40 €

NLGBSP-01si



Spot, 68ø, schwenkbar,
silber gebürstet

14,40 €

NLGBSP-01bk



Spot, 68ø, schwenkbar,
schwarz

14,40 €



WDLS-01



Wand-/Deckenleuchte PRO
25W, weiß, IP65, Ø300mm,
H:87mm, 2.800lm, 4000K,
50.000h (L80/B10), 5 Jahre
Garantie.

95,30 €

WDLS-01S



Wand-/Deckenleuchte PRO
26W, weiß mit vernetzba-
rem Sensor , IP65, Ø300mm,
H:87mm, 2.800lm, 4000K,
50.000h (L80/B10), 5 Jahre
Garantie.

120,90 €

WDLW-01



IK10 (schlagfest)

WDLW-01S



50.000h
L80/B10

IP65

IK10
schlagfest

mit & ohne
SENSOR

NSSL-06W



Downlight CCT 6W , Vario K
(2.700K/4.000K/5.700K) , 600lm,
Sägemaß Ø73-82, AD Ø90mm,
Einbautiefe 10mm/20mm,
CRI>85, 40.000h, inkl. Treiber
mit Farbwahlschalter

25,90 €

NSSL-10W



Downlight CCT 10W , Vario K
(2.700K/4.000K/5.700K), 1000lm,
Sägemaß Ø 108-112,
AD Ø120mm, Einbautiefe
10mm/20mm, CRI>85, 40.000h,
inkl. Treiber
mit Farbwahlschalter

32,50 €

NSSL-15W



Downlight CCT 15W , Vario K
(2.700K/4.000K/5.700K) , 1500lm,
Sägemaß Ø155-162,
AD Ø170mm, Einbautiefe
10mm/20mm, CRI>85, 40.000h,
inkl. Treiber
mit Farbwahlschalter

42,95 €

NSSL-24W



Downlight CCT 24W , Vario K
(2.700K/4.000K/5.700K) , 2400lm,
Sägemaß Ø205-217,
AD Ø225mm, Einbautiefe
10mm/20mm, CRI>85, 40.000h,
inkl. Treiber
mit Farbwahlschalter

48,95 €

NSSL-26W



Downlight CCT 26W , Vario K
(2.700K/4.000K/5.700K) , 2600lm,
Sägemaß Ø220-232,
AD Ø240mm, Einbautiefe
10mm/20mm, CRI>85, 40.000h,
inkl. Treiber
mit Farbwahlschalter

57,90 €

NSSL-30W



Downlight CCT 30W , Vario K
(2.700K/4.000K/5.700K) , 3000lm,
Sägemaß Ø280-292,
AD Ø300mm, Einbautiefe
10mm/20mm, CRI>85, 40.000h,
inkl. Treiber
mit Farbwahlschalter

71,50 €

Leuchten und Spots Rettungswegbeleuchtung

NOT-01A



Rettungszeichenleuchte IP65 LED 3,0W mit Prüftaste, 160lm (140lm), inklusive aller Pictogramme, 20m, mit schaltbarem Eingang (L+Ls), nur Wandmontage.

94,95 €

NOT-01B



Rettungszeichenleuchte IP65 LED 5,5W mit Autotest, 300lm (190lm), inklusive aller Pictogramme, 20m, mit schaltbarem Eingang (L+Ls).

105,90 €

NOT-02A



Rettungszeichenleuchte VARIO mit Prüftaster, Displayleuchte inklusive aller Pictogramme, um 90° schwenkbare Wand-Deckeneinheit, Erkennungsweite 26m, 3h, 2W LED, IP40.

130,90 €

NOT-02B



Rettungszeichenleuchte VARIO mit Selbstüberwachung, Displayleuchte inklusive aller Pictogramme, um 90° schwenkbare Wand-Deckeneinheit, Erkennungsweite 26m, 3h, 2W LED, IP40, Wand- und Deckenmontage.

149,90 €

NOT-03A

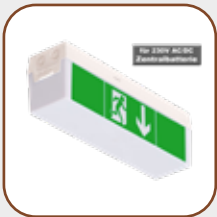

Rettungszeichenleuchte RAT IP54 LED für Zentralbatterie Erkennungsreichweite 14m.

147,90 €

NOT-03B

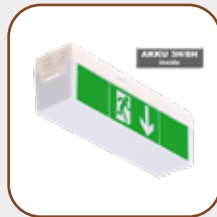

Rettungszeichenleuchte RAT IP54 LED mit Autotest 1h/3h/8h Wahlschalter.

154,30 €



WDLS-01



Sicherheitsleuchte SAVE 3h Deckenaufbauvariante, inkl. drei Linien für hohe Räume, für Räume bis H=4m, SMD-LED, Akku: Ni-CD 3,6 V / 2,0 Ah Betriebsdauer: 3h/8h, umschaltbar AUTOTESTFUNKTION

155,95 €

WDLS-01S



Sicherheitsleuchte SAVE 3h Deckeneinbauvariante, Ø68mm, inkl. drei Linien für hohe Räume, für Räume bis H=4m und für Flure/Fluchtwege, (asymmetrisch strahlend), IP 20, Nennleistung: 3 W, SMD-LED Akku: Ni-CD 3,6 V / 2,0 Ah Betriebsdauer: 3h/8h, umschaltbar AUTOTESTFUNKTION.

155,95 €

WDLW-01



Sicherheitsleuchte SAVE für Batterieanlagen 230V, Ø68mm, inkl. Flächenlinse Montagehöhe bis 8m, OPTIONAL Flurlinsen erhältlich, Montageart: Deckeneinbau, 280lm Schutzart: IP 40 Schutzklasse: II Nennleistung: 3 W Leuchtmittel: SMD-LED Made in Germany.

185,50 €



Für 's Büro

BPL-01nw-ws



LED-Pendelleuchte, 4000K, UGR19, sw, 74W, 7200lm, IP54, phasendimmbar, bildschirmarbeitsplatztauglich nach DIN EN 12464-1, 50.000h, 5 Jahre Garantie.
BxHxL: 45x40x2.000mm

412,50 €

BPL-01nw-ws



Office Light LED 40W, 4.000K, UP(opal, 30%) - DOWN(MicroRef, 70% UGR<16), IP20, 240VAC 50Hz, 4.000lm, 50.000h, flickerfrei, bildschirmarbeitsplatztauglich <UGR16,
BxHxL: 35x70x1200mm

346,50 €

BPL-01nw-sw



LED-Pendelleuchte, 4000K, UGR19, sw, 74W, 7200lm, IP54, phasendimmbar, bildschirmarbeitsplatztauglich nach DIN EN 12464-1, 50.000h, 5 Jahre Garantie.
BxHxL: 45x40x2.000mm

412,50 €

BPL-01nw-sw



Office Light LED 50W, 4.000K, UP(opal, 30%) - DOWN(MicroRef, 70% UGR<16), IP20, 240VAC 50Hz, 5.000lm, 50.000h, flickerfrei, bildschirmarbeitsplatztauglich <UGR16,
BxHxL: 35x70x1200mm

408,90 €

BPL-01cw-ws



LED-Pendelleuchte, 4000K, UGR19, sw, 74W, 7200lm, IP54, phasendimmbar, bildschirmarbeitsplatztauglich nach DIN EN 12464-1, 50.000h, 5 Jahre Garantie.
BxHxL: 45x40x2.000mm

412,50 €

BPL-01cw-ws



UP/DOWN Office Stehleuchte 80W, 4.000K, silbergrau, UP 4.600lm (UGR<23) / DOWN 4.200lm (UGR<17), dimmbar, H: 1950mm mit Standfuß, 50.000h.

1224,90 €

BPL-01cw-sw



LED-Pendelleuchte, 6000K, UGR19, sw, 6000K, 74W, 7200lm, IP54, phasendimmbar, bildschirmarbeitsplatztauglich nach DIN EN 12464-1, 50.000h, 5 Jahre Garantie.
BxHxL: 45x40x2.000mm

412,50 €

BPL-01cw-sw



UP/DOWN Office Tischleuchte 80W, 4.000K, UP 4.600lm (UGR23) / DOWN 4.200lm (UGR<17), dimmbar, für Tischbefestigung, silbergrau, 50.000h.

1030,50 €

Ringleuchten Cyclone Gruppe



Ringleuchte Cyclone Slim ist eine Leuchte die als Pendel- oder als Deckenleuchte montiert werden kann. Im Standard sind die Leuchten als an/aus und in den Farben weiss, schwarz und titan erhältlich. (optional sind die Leuchten dimmbar, in jeder RAL-Farbe und mit grösseren Radien bestellbar).

RLD-0600-38-3	Ringleuchte, 38Watt, 3000K, ø600mm aussen, ø450mm innen	999,00 €/Stk.
RLD-0600-38-4	Ringleuchte, 38Watt, 4000K, ø600mm aussen, ø450mm innen	999,00 €/Stk.
RLD-0800-52-3	Ringleuchte, 52Watt, 3000K, ø800mm aussen, ø650mm innen	1299,00 €/Stk.
RLD-0800-52-4	Ringleuchte, 52Watt, 4000K, ø800mm aussen, ø650mm innen	1299,00 €/Stk.
RLD-1100-79-3	Ringleuchte, 79Watt, 3000K, ø1100mm aussen, ø950mm innen	1899,00 €/Stk.
RLD-1100-79-4	Ringleuchte, 79Watt, 4000K, ø1100mm aussen, ø950mm innen	1899,00 €/Stk.
RLD-1450-99-3	Ringleuchte, 99Watt, 3000K, ø1450mm aussen, ø1300mm innen	1999,00 €/Stk.
RLD-1450-99-4	Ringleuchte, 99Watt, 4000K, ø1450mm aussen, ø1300mm innen	1999,00 €/Stk.

Tischlampen

TLGB-SW01



TLGB-GN01



TLGB-RT01



TLGB-GE01



TLGB-WS01



TLGB-GR01



TLGB-BR01



Halterung HIGHLIGHT für Mastaufbau, passend für alle Masten mit einem Durchmesser zwischen 50mm und 76mm.

Abmessungen: 120x170mm, langlebiger Stahl, schwarz.

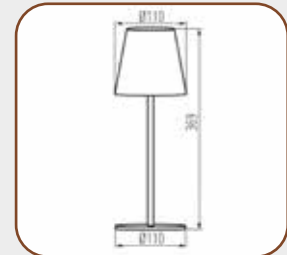

TLGB-SW01	LED Akku Tischleuchte schwarz, dimmbar	65,00 €/Stk.
TLGB-GN01	LED Akku Tischleuchte grün, dimmbar	65,00 €/Stk.
TLGB-RT01	LED Akku Tischleuchte rot, dimmbar	65,00 €/Stk.
TLGB-GE01	LED Akku Tischleuchte gelb, dimmbar	65,00 €/Stk.
TLGB-WS01	LED Akku Tischleuchte weiß, dimmbar	65,00 €/Stk.
TLGB-GR01	LED Akku Tischleuchte grau, dimmbar	65,00 €/Stk.
TLGB-BR01	LED Akku Tischleuchte braun, dimmbar	65,00 €/Stk.



SNLP-01rw

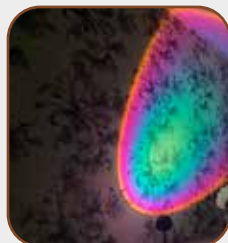

Standlinsenlampe, SNLP-01rw, rainbow (Lichteffekt rot, blau, weiss) 5W, 5VDC, 120cm Anschlusskabel mit An- Ausschalter, USB-Anschluss, Adapter 230VAC/ 5VDC (weiss), Metall/ Alu Gehäuse in schwarz.

68,20 €



SNLP-01or



Standlinsenlampe, SNLP-01or, orange (Lichteffekt orange) 5W, 5VDC, 120cm Anschlusskabel mit An- Ausschalter, USB-Anschluss, Adapter 230VAC/ 5VDC (weiss), Metall/Alu Gehäuse in schwarz.

68,20 €

SNLP-01ye



Standlinsenlampe, SNLP-01ye, amber (Lichteffekt amber) 5W, 5VDC, 120cm Anschlusskabel mit An- Ausschalter, USB-Anschluss, Adapter 230VAC/ 5VDC (weiss), Metall/Alu Gehäuse in schwarz.

68,20 €



SNLP-01yo



Standlinsenlampe, SNLP-01yo, gelb-orange (Lichteffekt amber mit orange) 5W, 5VDC, 120cm Anschlusskabel mit An- Ausschalter, USB-Anschluss, Adapter 230VAC/ 5VDC (weiss), Metall/ Alu Gehäuse in schwarz.

68,20 €

Flutlichtstrahler und High Bay´s

NLFLS-030-40B NLFLS-050-40B NLFLS-100-40B NLFLS-150-40B NLFLS-200-40B NLFLS-300-40B



Halterung HIGHLIGHT für Mastaufbau,
passend für alle Masten mit einem
Durchmesser zwischen 50mm und 76mm.
Abmessungen: 120x170mm, langlebiger Stahl, schwarz.

122,95 €/Stk.



NLFLS-030-40B	LED Fluter HIGHLIGHT, 30W, 4.000K, 4650lm	265,50 €/Stk.
NLFLS-050-40B	LED Fluter HIGHLIGHT, 50W, 4.000K, 7750lm	295,50 €/Stk.
NLFLS-100-40B	LED Fluter HIGHLIGHT, 100W, 4.000K, 16000lm	398,50 €/Stk.
NLFLS-150-40B	LED Fluter HIGHLIGHT, 150W, 4.000K, 24000lm	510,90 €/Stk.
NLFLS-200-40B	LED Fluter HIGHLIGHT, 200W, 4.000K, 32000lm	595,00 €/Stk.
NLFLS-300-40B	LED Fluter HIGHLIGHT, 300W, 4.000K, 48000lm	825,00 €/Stk.

NLFLS-0230-57SS

NLFLS-0450-57SS

NLFLS-0650-57SS



Star Sport Stadionstrahler 230W, 5.700K,
33.700lm, 1x2 Module, IP66, CRI>70, -30°C - +50°C,
IK10, D-Zertifikat, ENEC- Zukassung 50.000h
LxBxH : 373x340x185mm

1550,00 €/Stk.

Star Sport Stadionstrahler 450W, 5.700K,
65.700lm, 2x2 Module, IP66, CRI>70, -30°C - +50°C,
IK10, D-Zertifikat, ENEC- Zukassung 50.000h
LxBxH : 685x390x249mm

3140,95 €/Stk.

Star Sport Stadionstrahler 650W, 5.700K, 100.100lm,
65.700lm, 3x2 Module, IP66, CRI>70, -30°C - +50°C, IK10, D-Zerti-
fikat, ENEC- Zukassung 50.000h
LxBxH : 890x390x249mm

4645,50 €/Stk.

NLFLS-0900-57SS

**Flutlichtstrahler
STAR SPORT**

NLFLS-240-40HB



Star Sport Stadionstrahler 900W, 5.700K,
134.000lm, 4x2 Module, IP66, CRI>70, -30°C - +50°C,
IK10, D-Zertifikat, ENEC- Zukassung 50.000h
LxBxH : 685x700x249mm

5955,95 €/Stk.

Star Sport Stadionstrahler 1.350W, 5.700K,
200.000lm, 6x2 Module, IP66, CRI>70, -30°C
- +50°C, IK10, D-Zertifikat, ENEC- Zukassung
50.000h
LxBxH : 890x700x249mm

8330,00 €/Stk.

Flutlichtstrahler und High Bay´s

PHILIPS DRIVE SERIE 8 Hallenstrahler, 4.000K
PHILIPS XTANIUM Treiber 1-10V dimmbar, flickerfrei,
120° Abstrahlwinkel, 50.000h, 5 Jahre Garantie.



FLHB-PH-100-4K	PHILIPS DRIVE SERIE 8 Hallenstrahler 100W, 13500lm, D238 x H122mm	169,00 €/Stk.
FLHB-PH-150-4K	PHILIPS DRIVE SERIE 8 Hallenstrahler 150W, 20.200lm, D223 x H128mm	189,00 €/Stk.
FLHB-PH-200-4K	PHILIPS DRIVE SERIE 8 Hallenstrahler 200W, 26500lm, D324 x H138mm	219,00 €/Stk.
FLHB-PH-240-4K	PHILIPS DRIVE SERIE 8 Hallenstrahler 240W, 32400lm, D363 x H140mm	245,00 €/Stk.

High Bay Tube, Langfeld - Hallenstrahler mit Mean Well Treiber, Korpus Aluminium, Diffusor schlagfestes Polycarbonat opal



FLHB-TU-070-4K	High Bay Tube 70W 8.400lm 4.000K, mit MeanWell-Treiber, IP65, 230V L: 350mm	333,00 €/Stk.
FLHB-TU-070-6K	High Bay Tube 70W 8.400lm 6.000K, mit MeanWell-Treiber, IP65, 230V L: 350mm	333,00 €/Stk.
FLHB-TU-100-4K	High Bay Tube 100W 12.000lm 4.000K, mit MeanWell-Treiber, IP65, 230V L: 500mm	391,50 €/Stk.
FLHB-TU-100-6K	High Bay Tube 100W 12.000lm 6.000K, mit MeanWell-Treiber, IP65, 230V L: 500mm	391,50 €/Stk.
FLHB-TU-150-4K	High Bay Tube 150W 18.000lm 4.000K, mit MeanWell-Treiber, IP65, 230V L: 750mm	462,50 €/Stk.
FLHB-TU-150-6K	High Bay Tube 150W 18.000lm 6.000K, mit MeanWell-Treiber, IP65, 230V L: 750mm	462,50 €/Stk.
FLHB-TU-200-4K	High Bay Tube 200W 24.000lm 4.000K, mit MeanWell-Treiber, IP65, 230V L: 1000mm	589,50 €/Stk.
FLHB-TU-200-6K	High Bay Tube 200W 24.000lm 6.000K, mit MeanWell-Treiber, IP65, 230V L: 1000mm	589,50 €/Stk.
FLHB-TU-250-4K	High Bay Tube 250W 30.000lm 4.000K, mit MeanWell-Treiber, IP65, 230V L: 1200mm	809,50 €/Stk.
FLHB-TU-250-6K	High Bay Tube 250W 30.000lm 6.000K, mit MeanWell-Treiber, IP65, 230V L: 1200mm	809,50 €/Stk.



Feuchtraumwannenleuchten

FRWLR-01.21nw



Feuchtraumwannenleuchte 01.21.
21Watt 2520lm, 120lm/Watt, RA>80,
4000K, direkt 230VAC,
IP65, 50000 Std. mit
Durchgangsverdrahtung 3x1,5 und
Boden-Schnellanschluss-Boxen

60,95 €/Stk.

FRWLR-01.33nw



Feuchtraumwannenleuchte 01.33.
33Watt 3960lm, 120lm/Watt, RA>80,
4000K, direkt 230VAC,
IP65, 50000 Std. mit
Durchgangsverdrahtung 3x1,5 und
Boden-Schnellanschluss-Boxen

93,50 €/Stk.

FRWLR-01.40nw



Feuchtraumwannenleuchte 01.40.
40Watt, 4800lm, 120lm/Watt, RA>80,
4000K, direkt 230VAC,
IP65, 50000 Std. mit
Durchgangsverdrahtung 3x1,5 und
Boden-Schnellanschluss-Boxen

88,95 €/Stk.

FRWLR-01.55nw



Feuchtraumwannenleuchte 01.55.
55Watt 6600lm, 120lm/Watt, RA>80,
4000K, direkt 230VAC,
IP65, 50000 Std. mit
Durchgangsverdrahtung 3x1,5 und
Boden-Schnellanschluss-Boxen

112,90 €/Stk.

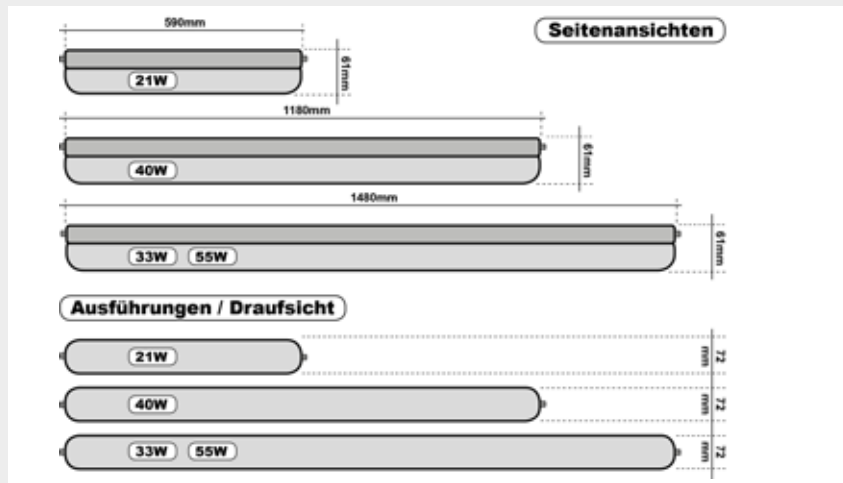

FRWLR-EKO-01



Feuchtraumwannenleuchte EKO-01.
40Watt 4400lm, 110lm/Watt, RA>80,
4000K, direkt 230VAC,
IP65, 25000 Std. mit
Durchgangsverdrahtung 3x1,5
BxHxL: 35x55x1235mm

69,80 €

FRWLR-EKO-02



Feuchtraumwannenleuchte EKO-02.
50Watt 5500lm, 110lm/Watt, RA>80,
4000K, direkt 230VAC,
IP65, 25000 Std. mit
Durchgangsverdrahtung 3x1,5
BxHxL: 35x55x1535mm

78,50 €

FRWL-EX01-40



Explosiongeschützte LED-Feuchtraumleuchte
EX-Zone: 2 und 22
EXTRA-N-LED-7500-258-G2-4K
L80B10ta30 - 70.000h
L70B10ta30 - 100.000h
1580 x 155 x 105 mm
EX II 3G Ex nR IIC T6 Gc
EX II 3D Ex tc IIIC T62°C Dc
Leistung: 44 W
Schutzart: IP 66
624,75 €

Feuchtraumwannenleuchten

FRWLR-AL69K



Feuchtraumwannenleuchte Animal Light LED IP69K 40W, 4.000K, inkl. 100cm Anschlusskabel H05RN-F 3G1.5 mm² "D" zertifiziert nach EN 60598-2-24 für feuergefährdete Betriebsstätten, Kabeldurchführungen Edelstahl, DLG zertifiziert : geeignet für ammoniakhaltige Umgebungen, resistent gegen Fette und Industrieöle, Material: PMMA + Edelstahl, IK09 (schlagfest), IP69K, Länge: 1500mm, Ø 70mm, mit H05RN-F Kabel 100cm, 190.000h (L70/B50), 100.000h (L80/B10), 5 Jahre Garantie.

297,00 €/Stk.



Mastleuchten

FLML-040-01



FLML-060-01



FLML-100-01



FLML-150-01



FLML-DS-01



FLML-AD-01



Mastleuchte

Ø60mm Zopfmaß, IP66, schlagfest IK10, geeignet für Mast - Ansatz und - Aufsatz, 6kV Überspannungsschutz integriert, optionaler PLUG&PLAY Dämmerungssensor integrierbar, CRI>70, Abstrahlwinkel: 140°/80°, 150lm/W, ENEC zertifiziert, TÜV, 100.000h, 5 Jahre Garantie.

NLML-WH-01



NLML-DM-01



FLML-040-01	Mastleuchte 40W 4.000K BRIDGELUX-Chips, 5.600lm, 405mm x 117mm	239,00 €/Stk.
FLML-060-01	Mastleuchte 60W 4.000K BRIDGELUX-Chips, 9.000lm, 494mm x 155mm	307,50 €/Stk.
FLML-100-01	Mastleuchte 100W 4.000K BRIDGELUX-Chips, 14.000lm, 625mm x 200mm	495,00 €/Stk.
FLML-150-01	Mastleuchte 150W 4.000K BRIDGELUX-Chips, 22.500lm, 625mm x 200mm	610,00 €/Stk.
FLML-AD-01	Straßenleuchtenadapter 60mm auf 76mm, starr	85,25 €/Stk.
FLML-WH-01	Wandhalter für Strassenleuchten, verzinkt, 60er Zopfmaß 15 Grad, 135x185x215mm	85,25 €/Stk.
FLML-DM-01	Y-Halter für Strassenleuchten, verzinkt, 60er Zopfmaß	129,50 €/Stk.
FLML-DS-01	Dämmerungssensor für außen IP67, 6 bis 50 Lux, Ø 84mm, 100.000 Zündzyklen	49,50 €/Stk.

Anschlussmaterial



2,98 €/Stk.

NLSCV-02

LED-Verbinder zweipolig. Einfaches anklennen ohne löten. LED-Streifen bis 10mm Breite einfach einschieben.
BxHxL: 14,3x5x15mm



3,85 €/Stk.

NLSCV-04T2

LED-Verbinder vierpolig transparent. Einfaches anklennen ohne löten. LED-Streifen bis 10mm Breite (beidseitig) einfach einschieben und einklemmen.
BxHxL: 14,5x7,5x19,5mm



2,98 €/Stk.

NLSCV-03

LED-Verbinder dreipolig. Einfaches anklennen ohne löten. LED-Streifen bis 10mm Breite einfach einschieben.
BxHxL: 14,3x5x15mm



4,98 €/Stk.

NLSCV-05T2

LED-Verbinder fünfpolig transparent. Einfaches anklennen ohne löten. LED-Streifen bis 12mm Breite (beidseitig) einfach einschieben und einklemmen.
BxHxL: 14,5x7,5x19,5mm



3,20 €/Stk.

NLSCV-04

LED-Verbinder vierpolig. Einfaches anklennen ohne löten. LED-Streifen bis 10mm Breite einfach einschieben.
BxHxL: 14,3x5x15mm



4,50 €/Stk.

NLSCV-02T3

LED-Verbinder zweipolig transparent. Einfaches anklennen ohne löten. LED-Streifen bis 10mm Breite (beidseitig) einfach einschieben und einklemmen. Anschlusskabel einführen und einklemmen.
BxHxL: 14,5x7,5x19,5mm



3,20 €/Stk.

NLSCV-05

LED-Verbinder vierpolig. Einfaches anklennen ohne löten. LED-Streifen bis 12mm Breite einfach einschieben.
BxHxL: 17x5x16mm



4,50 €/Stk.

NLSCV-03T3

LED-Verbinder dreipolig transparent. Einfaches anklennen ohne löten. LED-Streifen bis 10mm Breite (beidseitig) einfach einschieben und einklemmen. Anschlusskabel einführen und einklemmen.
BxHxL: 14,5x7,5x19,5mm



4,50 €/Stk.

NLSCV-02T2

LED-Verbinder zweipolig transparent. Einfaches anklennen ohne löten. LED-Streifen bis 10mm Breite (beidseitig) einfach einschieben und einklemmen.
BxHxL: 14,5x7,5x19,5mm



4,98 €/Stk.

NLSCV-04T3

LED-Verbinder vierpolig transparent. Einfaches anklennen ohne löten. LED-Streifen bis 10mm Breite (beidseitig) einfach einschieben und einklemmen. Anschlusskabel einführen und einklemmen.
BxHxL: 14,5x7,5x19,5mm



4,50 €/Stk.

NLSCV-03T2

LED-Verbinder dreipolig transparent. Einfaches anklennen ohne löten. LED-Streifen bis 10mm Breite (beidseitig) einfach einschieben und einklemmen.
BxHxL: 14,5x7,5x19,5mm



4,98 €/Stk.

NLSCV-05T3

LED-Verbinder fünfpolig transparent. Einfaches anklennen ohne löten. LED-Streifen bis 12mm Breite (beidseitig) einfach einschieben und einklemmen. Anschlusskabel einführen und einklemmen.
BxHxL: 14,5x7,5x19,5mm



Anschlussmaterial

Einspeisekabel mit Klammer zum lötfreiem Verbindenden von LED-Streifen

NLSCK-02



Einspeisekabel
für zweipolige
LED-Streifen

5,30 €/Stk.

NLSCK-03



Einspeisekabel
für dreipolige
LED-Streifen

5,30 €/Stk.

NLSCK-04



Einspeisekabel
für vierpolige
LED-Streifen

5,50 €/Stk.

NLSCK-05



Einspeisekabel
für fünfpolige
LED-Streifen

5,50 €/Stk.

NLSCK-02



Einspeisekabel
für zweipolige
LED-Streifen

5,30 €/Stk.

NLSCK-03



Einspeisekabel
für dreipolige
LED-Streifen

5,30 €/Stk.

NLSCK-04



Einspeisekabel
für vierpolige
LED-Streifen

5,50 €/Stk.

NLSCK-05



Einspeisekabel
für fünfpolige
LED-Streifen

5,50 €/Stk.

Verbindungskabel mit Klammern zu lötfreiem Verbindenden von LED-Streifen

NLSVK-02



Verbindungskabel
für zweipolige
LED-Streifen

5,50 €/Stk.

NLSVK-03



Verbindungskabel
für dreipolige
LED-Streifen

5,50 €/Stk.

NLSVK-04

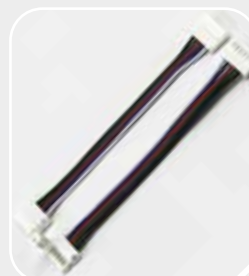

Verbindungskabel
für vierpolige
LED-Streifen

5,70 €/Stk.

NLSVK-05



Verbindungskabel
für fünfpolige
LED-Streifen

5,70 €/Stk.

Anschlussmaterial



3,79 €/Set.

ASDC-SET-01Anschlussstecker-Set 01
Sekundärseitig

7,50 €/Stk.

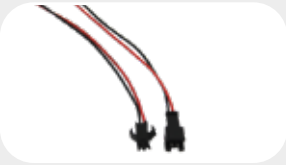
NLAK-240w / bAnschluss-Kabel
Säkunderseitig mit
Euroanschlussstecker
weiß oder schwarz

3,69 €/Set.

ASDC-SET-02Anschlussstecker-Set 02
Sekundärseitig

8,50 €/Stk.

NLAKS-240Anschluss-Kabel Säkunderseitig
mit Ein/Aus Schalter und
Euroanschlussstecker

17,90 €/Stk.

NLAB-01Anschlussbox-01 für LED-Streifen oder
Spots mit 180mm Zuleitung. 6VDC-
24VDC, 3A,max, IP20. Sechs Anschlüsse
über Stecksystem. Die Anschlussleitung
finden Sie unter der Art.Nr.: NLAL-01

3,20 €/Stk.

NLAL-01Anschlussleitung-01 mit
Stecker, passend für
NLAB-01 Länge 180mm

4,50 €/Stk.

NLAK-02DCAnschlusskabel Zweiadrig,
Sekundärseitig mit
Anschlussbuchse.
2,5m Länge

7,50 €/Stk.

NLAKS-02DCAnschlusskabel Zweiadrig,
Transparent, Sekundärseitig mit
Sachalter und Anschlussbuchse.
1,5m Länge

4,50 €/Stk.

NLAK-ST02DCwAnschlusskabel mit Stecker, weiß
Doppelt ummantelt, 150mm.
DC-Anschlussstecker
(Hohlstecker) zu offen verzinnt.

49,90 €/Stk.

NLMBES-01Montagebox aus Edelstahl glänzend.
Ideal zum unterbringen von
Netzteilen und Steuerungen.
BxHxL: 100x49x246mm.

43,50 €/Stk.

NLMBL-01sLängliche Montagebox in silber. Ideal
zum unterbringen von Netzteilen und
Steuerungen.
BxHxL: 50x27x403mm

43,50 €/Stk.

NLMBL-01bLängliche Montagebox in
schwarz. Ideal zum unterbringen
von Netzteilen und Steuerungen.
BxHxL: 50x27x403mm

59,50 €/Stk.

NLMBR-01sMontagebox rund in silber. Ideal
zum unterbringen von
Netzteilen und Steuerungen.
BxH: 352x35mm

59,50 €/Stk.

NLMBR-01bMontagebox rund in schwarz.
Ideal zum unterbringen von
Netzteilen und Steuerungen.
BxH: 352x35mm

2,15 €/Stk.

GU10-FA01GU10 Fassung, keramisch mit
Anschlusslitze, max 250V AC,
max 2A, CE.

2,65 €/Stk.

E27BV-01 o. E27BV-02E27 Fassung 01, Kunststoff mit
Lüsterklemmen oder
E27 Fassung 02, Kunststoff mit
Leuchtenklemme.

Anschlussmaterial



8,10 €/m

NLAK-TP02

Anschluss-Kabel,
Meterware transparent,
Doppelt ummantelt, 2 x
0,75mm



4,50€/m

NLAK-OF03

Anschluss-Kabel,
Meterware, Doppelt
ummantelt, 35mm



8,95 €/m

NLAK-TP03

Anschluss-Kabel, Meterware
transparent, Doppelt ummantelt, 3 x
0,75mm



4,95 €/m

NLAK-OF05

Anschluss-Kabel, Meterware,
Doppelt ummantelt, 5 x 0,5mm



10,50 €/m

NLAK-TP05

Anschluss-Kabel, Meterware
transparent, Doppelt ummantelt,
5 x 0,75mm



3,80 €/m

NLAK-GM2075

Anschluss-Kabel, Meterware,
Doppelt ummantelt, Gummiert
2 x 0,75mm



3,40 €/m

NLAK-OF02

Anschluss-Kabel,
Meterware, Doppelt
ummantelt, 2 x 0,5mm



4,50 €/m

NLAK-GM5075

Anschluss-Kabel, Meterware,
Doppelt ummantelt, Gummiert
5 x 0,75mm

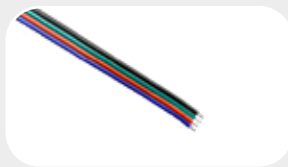

4,60 €/m.

NLAK-RGBW

Anschluss-Kabel, Meterware,
RGBW, 5x0,34mm² Kupfer,
PVC-ummantelt und
Farblich gekennzeichnet.

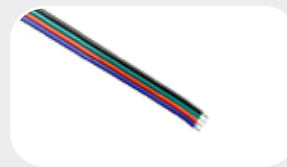

4,80 €/m

NLAK-RGBWW

Anschluss-Kabel, Meterware,
RGBWW, 6x0,34mm² Kupfer,
PVC-ummantelt und
Farblich gekennzeichnet.



Abhängungen



NLSAH-01

NORDSTAR
Stahlseil-Abhängung 01
(SET)

8,50 €/Stk.



NLSAH-02

NORDSTAR
Stahlseil-Abhängung 02 (SET)

8,90 €/Stk.



NLSAH-03

NORDSTAR
Stahlseil-Abhängung 03 (SET) einsetzbar
mit NLSS-01 Stahlseil zur Spannungsver-
sorgung von
Monochromen LED-Streifen (Niedervolt)

11,90 €/Stk.



NLSAH-04

NORDSTAR
Stahlseil-Abhängung 04 (SET)

17,90 €/Set.



NLSAH-05

NORDSTAR
Stahlseil-Abhängung 05 (SET)
Nutenstein

7,90 €/Stk.



NLSAH-06

NORDSTAR
Stahlseil-Abhängung 06 (SET)
zum durchführen von Stahlseil
und zum Aufbau einer
mehretagigen Leuchte

15,90 €/Stk.



NLSAH-07

NORDSTAR
Stahlseil-Abhängung 07 (SET)
Nutenstein

12,90 €/Stk.



NLSAH-08

NORDSTAR
Stahlseil-Abhängung 08 (SET)

26,90 €/Stk.

Stahlseil für Seilabhängung



NLAS-01

NORDSTAR Stahlseil 01 (Meterware)
mit Abschirmung. Ideal zur
Spannungsversorgung
(Niedervolt) der LED-Streifen.

3,95 €/m



NLAS-02

NORDSTAR Stahlseil 02
ohne Abschirmung
(Meterware)

2,50 €/m



NLAS-03

NORDSTAR Stahlseil 03
ohne Abschirmung mit
Endnippel, 2m

5,90 €/Stk.



NLAS-04

NORDSTAR Stahlseil 04
ohne Abschirmung mit
Schraubgewinde

6,90 €/Stk.



NLAS-05

NORDSTAR Stahlseil 05
6m Stahlseil in 1,5mm
mit Kausche.

39,50 €/Stk.



NLAS-06

NORDSTAR Stahlseil 06
ohne Abschirmung mit
Y-Abhängung

11,50 €/Stk.

Stecker und Klammern



9,50 €/Stk.

NLSUS-02S

Super Seal Stecker, zweipolig ohne Anschlusskabel.



9,80 €/Stk.

NLSUS-03S

Super Seal Stecker, dreipolig ohne Anschlusskabel.



10,50 €/Stk.

NLSUS-04S

Super Seal Stecker, vierpolig ohne Anschlusskabel.



11,00 €/Stk.

NLSUS-05S

Super Seal Stecker, fünfpolig ohne Anschlusskabel.



9,50 €/Stk.

NLSUS-02K

Super Seal Kupplung, zweipolig ohne Anschlusskabel.



9,80 €/Stk.

NLSUS-03K

Super Seal Kupplung, dreipolig ohne Anschlusskabel.



10,50 €/Stk.

NLSUS-04K

Super Seal Kupplung, vierpolig ohne Anschlusskabel.



11,00 €/Stk.

NLSUS-05K

Super Seal Kupplung, fünfpolig ohne Anschlusskabel.



10,50 €/Stk.

G3-SAK

Schnellanschlussstecker 1 auf 2 mit Anschraubblaschen ohne Anschlusskabel.

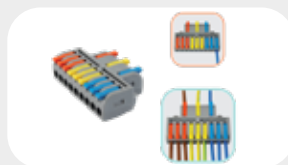

11,00 €/Stk.

G4-SAK

Schnellanschlussstecker 1 auf 3 mit Anschraubblaschen ohne Anschlusskabel.



10,50 €/Stk.

NLVS-01IP

Schnellanschlussstecker 1 auf 2 mit Anschraubblaschen ohne Anschlusskabel.



11,00 €/Stk.

NLVS-02IP

Schnellanschlussstecker 1 auf 3 mit Anschraubblaschen ohne Anschlusskabel.



10,50 €/Stk.

NLVS-03IP

Schnellanschlussstecker 1 auf 2 mit Anschraubblaschen ohne Anschlusskabel.



11,00 €/Stk.

NLVS-03IP

Schnellanschlussstecker 1 auf 3 mit Anschraubblaschen ohne Anschlusskabel.

LED-Einspeise- Verbindungskabel



5,90 €/Stk.

NLPUNI-WH01

Nordstar Universal Winkelhalter 01. In Kombination mit der entsprechenden Montageklammer oder dem Montageclip kann der Abstrahlwinkel kinderleicht bestimmt werden.

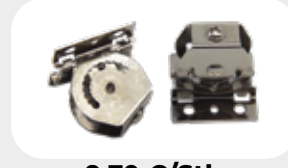

9,70 €/Stk.

NLPUNI-WH02

Nordstar Universal Winkelhalter 02. In Kombination mit der entsprechenden Montageklammer oder dem Montageclip kann der Abstrahlwinkel kinderleicht bestimmt werden.

Feuchtigkeitsschutz



27,50 €/Stk.

NLFS-70

Feuchtigkeitsschutz für Bereiche mit hoher Luftfeuchtigkeit, oder für den Geschützten Aussenbereich.



15,95 €/Stk.

NLBR-01

Oberflächen-Reiniger zur Reinigung und entfettung von Oberflächen. Schnelle Trocknungszeit.

Montagekleber



29,95 €/Stk.

MOK-SOU-D4

Soudal PU Construct D4 310ml, Hochleistungs-Kleber, Basis: Polyurethan, Feuchtigkeitshärtend (Luftfeuchtigkeit), Farbe: braun. Wasserfestigkeit D4 (DIN EN 204) Für Innen- und Außenbereiche Kann mit den meisten Arten von Anstrichsystemen überstrichen werden.



27,50 €/Stk.

MOK-SOU-250XF-G MOK-SOU-250XF-W MOK-SOU-250XF-S

Soudaseal 250 XF 290ml

Hochleistungs-Hybrid-Kleber Farbe: grau, weiß und schwarz

Beidseitig klebendes 3M-Band



39,90 €/Stk.

NLDK-3M-08

Doppelseitiges 3M Klebeband für LED-Streifen, mit optimaler Wärmeableitung 8mm



39,90 €/Stk.

NLDK-3M-10

Doppelseitiges 3M Klebeband für LED-Streifen, mit optimaler Wärmeableitung 10mm



39,90 €/Stk.

NLDK-3M-12

Doppelseitiges 3M Klebeband für LED-Streifen, mit optimaler Wärmeableitung 12mm

Klemmen



G2-HAK

Anschlussklammer 2Polig mit Klappfunktion

5,90 €/Set.



G3-HAK

Anschlussklammer 3Polig mit Klappfunktion

9,70 €/Set.



G5-HAK

Anschlussklammer 5Polig mit Klappfunktion

22,95 €/Set.



G1-DAK

Anschlussklammer 2Polig mit Druckklappfunktion

15,95 €/Set.



G2-DAK

Anschlussklammer 3Polig mit Druckklappfunktion

22,95 €/Set.



G2-AK

Anschlussklammer 2Polig

27,50 €/Set.



G3-AK

Anschlussklammer 3Polig

22,95 €/Set.



G4-AK

Anschlussklammer 4Polig

15,95 €/Set.



G5-AK

Anschlussklammer 5Polig

22,95 €/Set.



G8-AK

Anschlussklammer 8Polig

27,50 €/Set.



G3-SAK

Schnellanschlusstecker 1 auf 2 mit Anschraubtaschen ohne Anschlusskabel.

10,50 €/Set.



G4-SAK

Schnellanschlusstecker 1 auf 3 mit Anschraubtaschen ohne Anschlusskabel.

11,00 €/Set.

NORDSTAR



LED SOLUTIONS
Ihr kompetenter LED-Partner

Irrtümer, Druckfehler und Preisänderungen vorbehalten

Eine große Auswahl dieser und vieler weiterer Produkte finden Sie auf unserer Website

Besuchen Sie uns online auf www.nord-star.de

ver. 01.2025